INDEX

| | |
|--|----|
| I. Application | 4 |
| II. Preparation | 5 |
| 2. Connectors and wiring | 5 |
| 2.1 RS-232C Remote control | 5 |
| 2.2 LAN control | 5 |
| 2.3 Multi Monitors Connection | 6 |
| III. Communication specification | 7 |
| 3. Communication Parameter | 7 |
| 3.1 RS-232C Remote control | 7 |
| 3.2 LAN control | 7 |
| 3.3 Communication timing | 7 |
| 4. Communication Format | 8 |
| 4.1 Header block format (fixed length) | 9 |
| 4.2 Message block format | 11 |
| 4.3 Check code | 13 |
| 4.4 Delimiter | 14 |
| 5. Message type | 15 |
| 5.1 Get current Parameter from a monitor. | 15 |
| 5.2 "Get parameter" reply | 16 |
| 5.3 Set parameter | 18 |
| 5.4 "Set parameter" reply | 19 |
| 5.5 Commands | 20 |
| 5.5.1 Save Current Settings | 20 |
| 5.5.2 Get Timing Report and Timing reply. | 21 |
| 5.5.3 NULL Message | 22 |
| IV. Control Commands | 23 |
| 6. Typical procedure example | 23 |
| 6.1. How to change the "Backlight" setting. | 23 |
| 6.2. How to read the measurement value of the built-in temperature sensors. | 26 |
| 6.3. Operation Code (OP code) Table | 29 |
| 6.4. Operation Code (OP code) Table for INPUT CONFIGURATION | 44 |
| 7. Power control procedure | 45 |
| 7.1 Power status read | 45 |
| 7.2 Power control | 47 |

| | |
|--|-----|
| 8. Asset Data read and write | 49 |
| 8.1 Asset Data Read Request and reply | 49 |
| 8.2 Asset Data write | 51 |
| 9. Date & Time read and write | 53 |
| 9.1 Date & Time Read | 53 |
| 9.2 Date & Time Write | 55 |
| 10. Schedule read and write | 58 |
| 10.1 Schedule Read | 58 |
| 10.2 Schedule Write | 63 |
| 11. Self diagnosis | 73 |
| 11.1 Self-diagnosis status read | 73 |
| 12. Serial No. & Model Name Read | 75 |
| 12.1 Serial No. Read | 75 |
| 12.2 Model Name Read | 77 |
| 13. Security Lock | 79 |
| 13.1 Security Lock Control | 79 |
| 14. Direct TV Chanel Read & Write | 81 |
| 14.1 Direct TV Chanel Read & Reply | 81 |
| 14.2 Direct TV Chanel Write & Reply | 82 |
| 15. Daylight Saving read & write | 83 |
| 15.1 Daylight Saving Read | 83 |
| 15.2 Daylight Saving Write | 85 |
| 16. Firmware Version | 87 |
| 16.1 Firmware Version Read | 87 |
| 17. Auto ID | 89 |
| 17.1 Auto ID Execute | 89 |
| 17.2 Auto ID Complete | 91 |
| 17.3 Auto ID Reset | 93 |
| 18. Input Name | 94 |
| 18.1 Input Name Read | 94 |
| 18.2 Input Name Write | 96 |
| 18.3 Input Name Reset | 98 |
| 19. Power Save Mode | 100 |
| 19.1 Power Save Mode Read | 100 |
| 19.2 Power Save Mode Write | 102 |
| 19.3 Auto Power Save Time Read | 104 |
| 19.4 Auto Power Save Time Write | 105 |
| 19.5 Auto Standby Time Read | 107 |

| | |
|--|-----|
| 19.6 Auto Standby Time Write | 108 |
| 20. Setting Copy | 110 |
| 20.1 Setting Copy Read | 110 |
| 20.2 Setting Copy Write | 112 |
| 20.3 Setting Copy Start | 114 |
| 21. Security Enable | 116 |
| 21.1 Security Enable Read | 116 |
| 21.2 Security Enable Write | 118 |
| 22. LAN MAC Address | 120 |
| 22.1 LAN MAC Address Read | 120 |
| 23. Proof of Play | 122 |
| 23.1 Set Proof of Play Operation Mode | 122 |
| 23.2 Get Proof of Play Current | 124 |
| 23.3 Get Proof of Play Status | 126 |
| 23.4 Get Proof of Play Number to Number | 128 |

I. Application

This document defines the communications method for control of the NEC LCD monitor, MultiSync X841UHD, X981UHD, X651UHD when using an external controller.

II. Preparation

2. Connectors and wiring

2.1 RS-232C Remote control

Connector: 9-pin D-Sub

Cable: Cross (reversed) cable or null modem cable

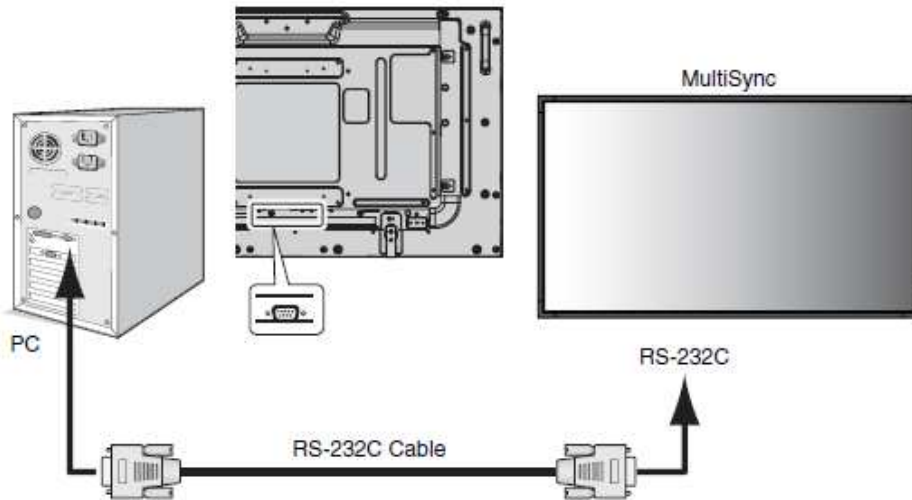

(Please refer "Controlling the LCD monitor via RS-232C Remote control" on User's manual.)

2.2 LAN control

Connector: RJ-45 10/100 BASE-T

Cable: Category 5 or higher LAN cable

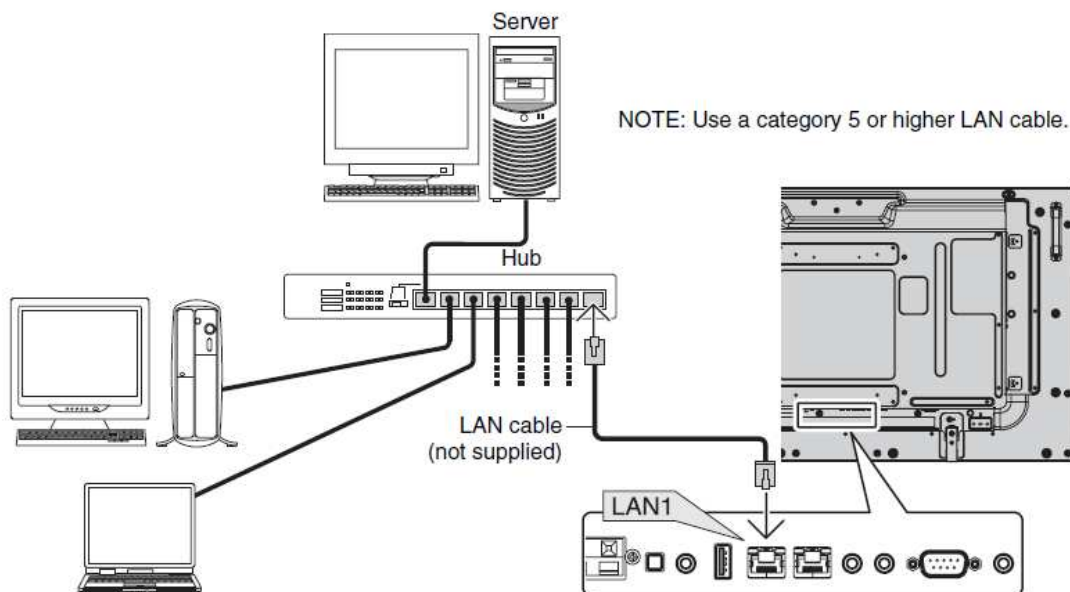

2.3 Multi Monitors Connection

You can control multiple monitors by using RS-232C, REMOTE IN or LAN daisy-chain connection.

| Main Monitor | | Sub Monitors | |
|--------------|------|--------------|------|
| Connector | | Connector | |
| IN | OUT | IN | OUT |
| RS-232C | LAN2 | LAN1 | LAN2 |
| REMOTE IN | | | |
| LAN1 | | | |

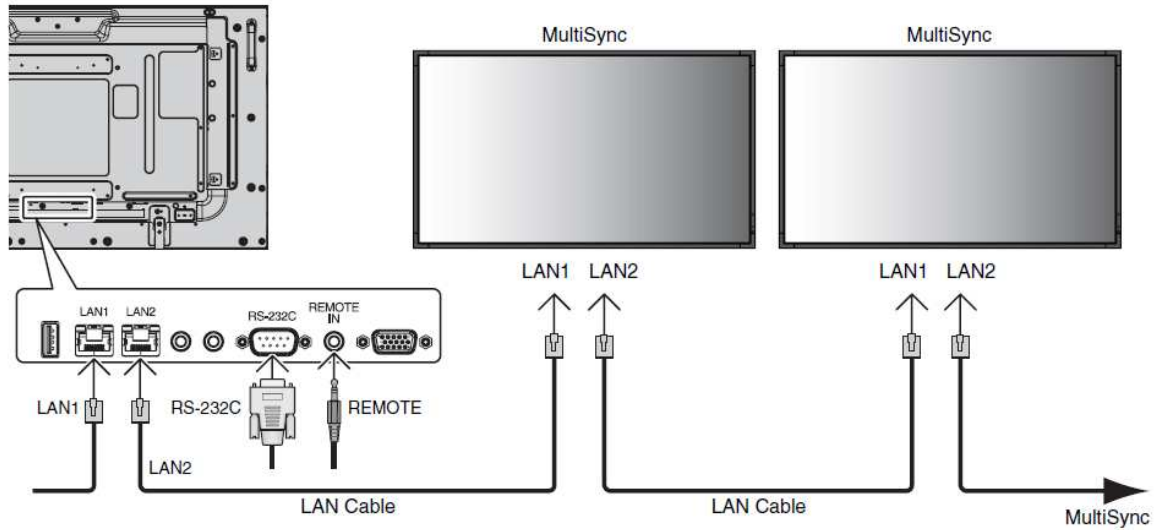

(Please refer "Controlling the LCD monitor via LAN control" on User's manual.)

In this connection, a command is transmitted to the connected MultiSync on the following environment.

1. AUTO ID function is performed on Main Monitor.
(Please refer "MULTI DISPLAY of OSD (On-Screen-Display) Controls" on User's manual.)
2. Destination byte of Command Header is "MONITOR ID = ALL", "GROUP ID" or "MONITOR ID of Sub Monitor".
(Please refer section 4.1.)

III. Communication specification

3. Communication Parameter

3.1 RS-232C Remote control

| | |
|--------------------------|--------------|
| (1) Communication system | Asynchronous |
| (2) Interface | RS-232C |
| (3) Baud rate | 9600bps |
| (4) Data length | 8bits |
| (5) Parity | None |
| (6) Stop bit | 1 bit |
| (7) Communication code | ASCII |

3.2 LAN control

| | |
|--------------------------|--|
| (1) Communication system | TCP/IP (Internet protocol suite) |
| (2) Interface | Ethernet (CSMA/CD) |
| (3) Communication layer | Transport layer (TCP) * Using the payload of TCP segment. |
| (4) IP address | (Default) Automatic setup * If you need to change, Please refer "Network settings" on User's manual. |
| (5) Port No. | 7142 (Fixed) |

(Note)

The monitor will disconnect the connection if no packet data is received for 15 minutes.
And the controller (PC) has to re-connect to control the monitor again, after 15 minutes or more.

3.3 Communication timing

The controller should wait for a reply packet before the next command is sent.

(Note)

When the following commands are sent, a controller should wait for specified period after receiving the reply command before sending the next command.

- Power On, Power Off: 15 seconds
- Input, PIP Input, Auto Setup, Factory Reset: 10 seconds

4. Communication Format

| | | | |
|--------|---------|------------|-----------|
| Header | Message | Check Code | Delimiter |
|--------|---------|------------|-----------|

The command packet consists of four parts, Header, Message, Check code and Delimiter.

Recommended sequence of a typical procedure to control a monitor is as follows,
 [A controller and a monitor, two-way communication composition figure]

- For the general command (see the part "6.3. Operation Code (OP code) Table")

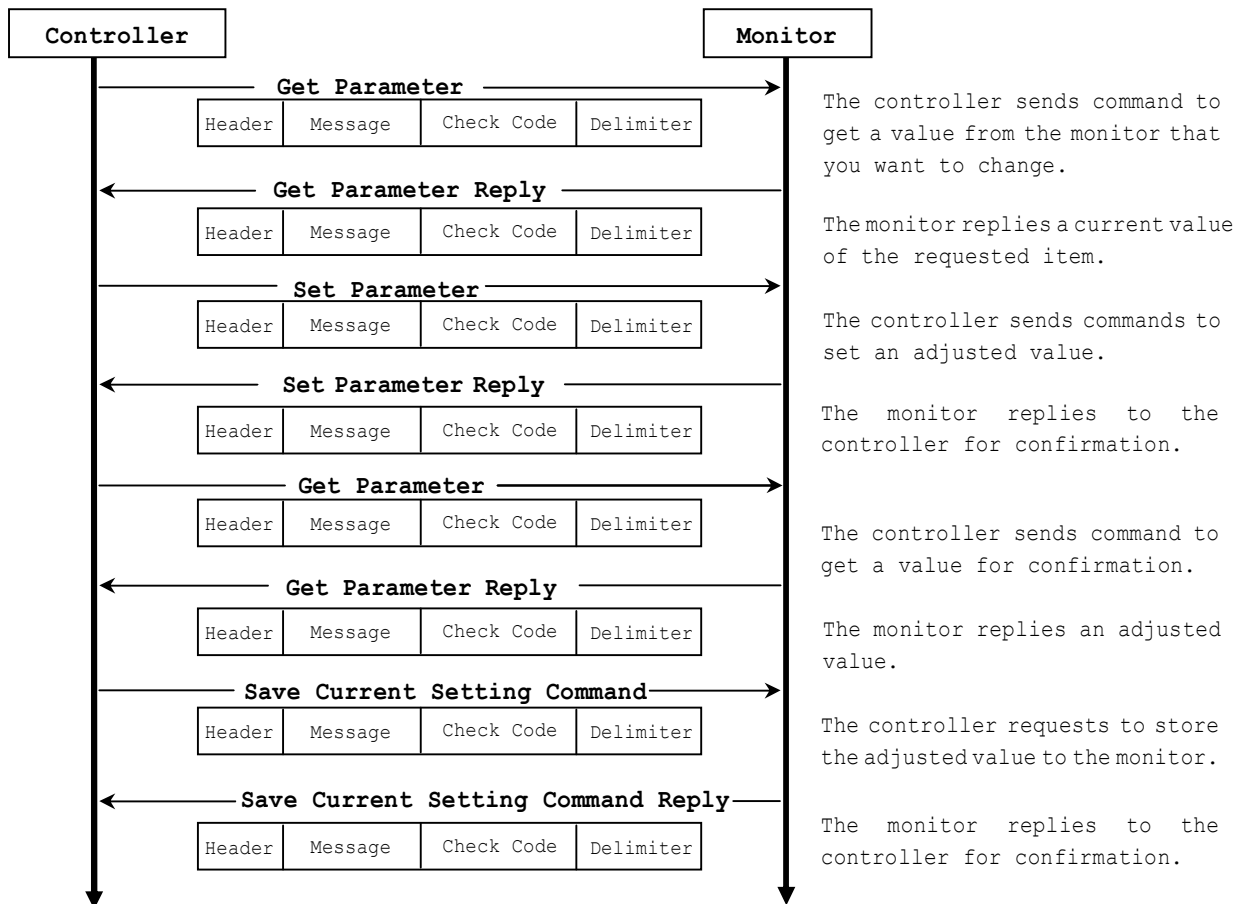

- For the special command (see the part 7 to 23. and 5.5.2)

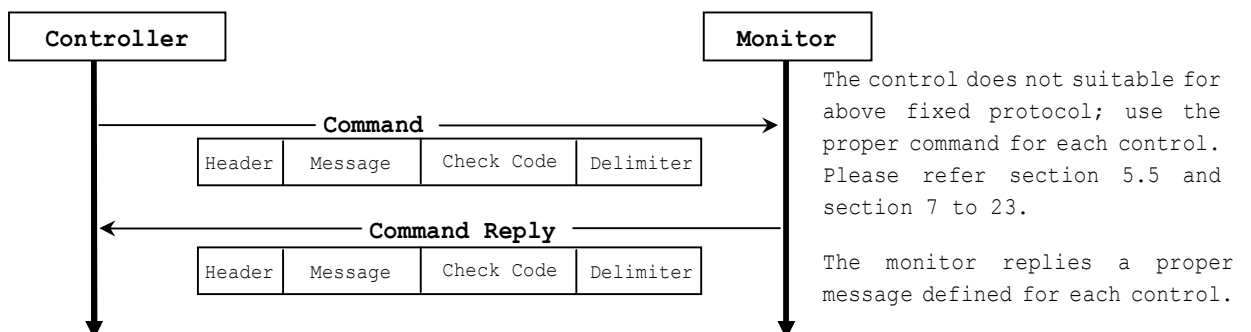

4.1 Header block format (fixed length)

| | | | |
|--------|---------|------------|-----------|
| Header | Message | Check code | Delimiter |
|--------|---------|------------|-----------|

| | | | | | |
|-----------------|-----------------|-----------------|-----------------|-----------------|-----------------------------------|
| SOH | Reserved '0' | Destination | Source | Message Type | Message Length |
| 1 st | 2 nd | 3 rd | 4 th | 5 th | 6 th - 7 th |

1stbyte) SOH: Start of Header
ASCII SOH (01h)

2ndbyte) Reserved: Reserved for future extensions.

On this monitor, it must be ASCII '0' (30h).

3rdbyte) Destination: Destination equipment ID. (Receiver)

Specify a commands receiver's address.

The controller sets the "MONITOR ID" or "GROUP ID" of the monitor controlled in here.

On the reply, the monitor sets '0' (30h), always.

"MONITOR ID", "GROUP ID" to "Destination Address" conversion table is as follows,

| Monitor ID | Destination Address | Monitor ID | Destination Address | Monitor ID | Destination Address | Monitor ID | Destination Address |
|------------|---------------------|------------|---------------------|------------|---------------------|------------|---------------------|
| 1 | 41h ('A') | 26 | 5Ah ('Z') | 51 | 73h | 76 | 8Ch |
| 2 | 42h ('B') | 27 | 5Bh | 52 | 74h | 77 | 8Dh |
| 3 | 43h ('C') | 28 | 5Ch | 53 | 75h | 78 | 8Eh |
| 4 | 44h ('D') | 29 | 5Dh | 54 | 76h | 79 | 8Fh |
| 5 | 45h ('E') | 30 | 5Eh | 55 | 77h | 80 | 90h |
| 6 | 46h ('F') | 31 | 5Fh | 56 | 78h | 81 | 91h |
| 7 | 47h ('G') | 32 | 60h | 57 | 79h | 82 | 92h |
| 8 | 48h ('H') | 33 | 61h | 58 | 7Ah | 83 | 93h |
| 9 | 49h ('I') | 34 | 62h | 59 | 7Bh | 84 | 94h |
| 10 | 4Ah ('J') | 35 | 63h | 60 | 7Ch | 85 | 95h |
| 11 | 4Bh ('K') | 36 | 64h | 61 | 7Dh | 86 | 96h |
| 12 | 4Ch ('L') | 37 | 65h | 62 | 7Eh | 87 | 97h |
| 13 | 4Dh ('M') | 38 | 66h | 63 | 7Fh | 88 | 98h |
| 14 | 4Eh ('N') | 39 | 67h | 64 | 80h | 89 | 99h |
| 15 | 4Fh ('O') | 40 | 68h | 65 | 81h | 90 | 9Ah |
| 16 | 50h ('P') | 41 | 69h | 66 | 82h | 91 | 9Bh |
| 17 | 51h ('Q') | 42 | 6Ah | 67 | 83h | 92 | 9Ch |
| 18 | 52h ('R') | 43 | 6Bh | 68 | 84h | 93 | 9Dh |
| 19 | 53h ('S') | 44 | 6Ch | 69 | 85h | 94 | 9Eh |
| 20 | 54h ('T') | 45 | 6Dh | 70 | 86h | 95 | 9Fh |
| 21 | 55h ('U') | 46 | 6Eh | 71 | 87h | 96 | A0h |
| 22 | 56h ('V') | 47 | 6Fh | 72 | 88h | 97 | A1h |
| 23 | 57h ('W') | 48 | 70h | 73 | 89h | 98 | A2h |
| 24 | 58h ('X') | 49 | 71h | 74 | 8Ah | 99 | A3h |
| 25 | 59h ('Y') | 50 | 72h | 75 | 8Bh | 100 | A4h |
| ALL | 2Ah ('*') | | | | | | |

| Group ID | Destination Address | Group ID | Destination Address | Group ID | Destination Address | Group ID | Destination Address |
|----------|---------------------|----------|---------------------|----------|---------------------|----------|---------------------|
| A | 31h ('1') | D | 34h ('4') | G | 37h ('7') | J | 3Ah (':') |
| B | 32h ('2') | E | 35h ('5') | H | 38h ('8') | | |
| C | 33h ('3') | F | 36h ('6') | I | 39h ('9') | | |

Ex.) If you want to control a monitor that has the "ID No." as '1', specify a destination address 'A' (41h). If you want to control all of the monitors which are connected by a daisy chain, specify a destination address '*' (2Ah).

4thbyte) Source: Source equipment ID. (Sender)

Specify a sender address.

The controller must be '0' (30h).

On the reply, the monitor sets the own MONITOR ID in here.

5thbyte) Message Type: (Case sensitive.)

Refer to section 4.2 "Message block format" for more details.

ASCII 'A' (41h): Command.

ASCII 'B' (42h): Command reply.

ASCII 'C' (43h): Get current parameter from a monitor.

ASCII 'D' (44h): "Get parameter" reply.

ASCII 'E' (45h): Set parameter.

ASCII 'F' (46h): "Set parameter" reply.

6th -7th bytes) Message Length:

Specify the length of the message (that follows the header) from STX to ETX.

This length includes STX and ETX.

The byte data must be encoded to ASCII characters.

Ex.) The byte data 3Ah must be encoded to ASCII characters '3' and 'A' (33h and 41h).

The byte data 0Bh must be encoded to ASCII characters '0' and 'B' (30h and 42h).

4.2 Message block format

| | | | |
|--------|----------------|------------|-----------|
| Header | Message | Check code | Delimiter |
|--------|----------------|------------|-----------|

"Message block format" is allied to the "Message Type" in the "Header".

Refer to the section 4.1 "Header block format" for more detail.

1) Get current parameter

The controller sends this message when you want to get the status of the monitor.

For the status that you want to get, specify the "OP code page" and "OP code", refer to "Appendix A. Operation code table".

"Message format" of the "Get current parameter" is as follows,

| | | | | | |
|-----|--------------|----|---------|----|-----|
| STX | OP code page | | OP code | | ETX |
| | Hi | Lo | Hi | Lo | |

➤ Refer to section 5.1 "Get current parameter from a monitor." for more details.

2) Get Parameter reply

The monitor will reply with the status of the requested item specified by the controller in the "Get parameter message".

"Message format" of the "Get parameter reply" is as follows,

| | | | | | | | | | | | | | | | |
|-----|--------|----|--------------|----|---------|----|------|----|-----------|--|--|---------------|-----|--|-----|
| STX | Result | | OP code page | | OP code | | Type | | Max value | | | Current Value | | | ETX |
| | Hi | Lo | Hi | Lo | Hi | Lo | Hi | Lo | MSB | | | LSB | MSB | | |

➤ Refer to section 5.2 "Get parameter reply" for more details.

3) Set parameter

The controller sends this message to change a setting of the monitor.

Message format of the "Set parameter" is as follows,

| | | | | | | | | |
|-----|--------------|----|---------|----|-----------|--|-----|-----|
| STX | OP code page | | OP code | | Set Value | | | ETX |
| | Hi | Lo | Hi | Lo | MSB | | LSB | |

➤ Refer to section 5.3 "Set parameter" for more details.

4) Set Parameter reply

The monitor replies with this message for a confirmation of the "Set parameter message".

Message format of the "Set parameter reply" is as follows,

| | | | | | | | | | | | | | | | |
|-----|--------|----|--------------|----|---------|----|------|----|-----------|--|--|-------------------------|-----|--|-----|
| STX | Result | | OP code page | | OP code | | Type | | Max value | | | Requested setting Value | | | ETX |
| | Hi | Lo | Hi | Lo | Hi | Lo | Hi | Lo | MSB | | | LSB | MSB | | |

➤ Refer to section 5.4 "Set parameter reply" for more details.

5) Command

"Command message" format depends on each command.

Usually, this "command message" is used for some non-slider controls and some special operations,

such as "Save current settings", "Get timing report", "power control", "Schedule", etc. Refer to section 5.5 "Commands message" for more details.

6) Command reply

The monitor replies to a query from the controller.

"Command reply message" format depends on each command.

Refer to section 5.5 "Commands message" for more details.

4.3 Check code

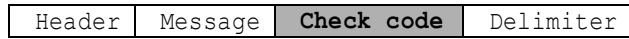

Check code is the Block Check Code (BCC) between the Header and the End of Message except SOH.

| | | | | | | | | | |
|-------------|-----------|-------|-------|-------|-------|-------|-------|-------|-------|
| | | 2^7 | 2^6 | 2^5 | 2^4 | 2^3 | 2^2 | 2^1 | 2^0 |
| SOH | D_0 | | | | | | | | |
| Reserved | D_1 | | | | | | | | |
| Destination | D_2 | | | | | | | | |
| Source | D_3 | | | | | | | | |
| Type | D_4 | | | | | | | | |
| Length (H) | D_5 | | | | | | | | |
| Length (L) | D_6 | | | | | | | | |
| STX | D_7 | | | | | | | | |
| Data | D_8 | | | | | | | | |
| | | | | | | | | | |
| | | | | | | | | | |
| ETX | D_n | | | | | | | | |
| Check code | D_{n+1} | P | P | P | P | P | P | P | P |

$$D_{n+1} = D_1 \text{ XOR } D_2 \text{ XOR } D_3 \text{ XOR } \dots \text{ XOR } D_n$$

XOR: Exclusive OR

Following is an example of a Check code (BCC) calculation.

| Header | | | | | | | Message | | | | | | | | | | Check code (BCC) | Delimiter |
|--------|----------|---------------------|----------------|--------------|----------------|-------|---------|--------------|-------|-----------|----------|----------|----------|----------|----------|----------|------------------|-----------|
| SOH | Reserved | Destination Address | Source Address | Message type | Message length | | STX | OP code page | | Set Value | | | | ETX | | | | |
| 01 | 30 | 41 | 30 | 45 | 30 | 41 | 02 | 30 | 30 | 31 | 30 | 30 | 30 | 36 | 34 | 03 | 77 | 0D |
| D_0 | D_1 | D_2 | D_3 | D_4 | D_5 | D_6 | D_7 | D_8 | D_9 | D_{10} | D_{11} | D_{12} | D_{13} | D_{14} | D_{15} | D_{16} | D_{17} | D_{18} |

$$\begin{aligned}
 \text{Check code (BCC) } D_{17} &= D_1 \text{ xor } D_2 \text{ xor } D_3 \text{ xor } \dots \text{ xor } D_{14} \text{ xor } D_{15} \text{ xor } D_{16} \\
 &= 30\text{h xor } 41\text{h xor } 30\text{h xor } 45\text{h xor } 30\text{h xor } 41\text{h} \\
 &\quad \text{xor } 02\text{h xor } 30\text{h xor } 30\text{h xor } 31\text{h xor } 30\text{h xor } 30\text{h} \\
 &\quad \text{xor } 30\text{h xor } 36\text{h xor } 34\text{h xor } 03\text{h} \\
 &= 77\text{h}
 \end{aligned}$$

4.4 Delimiter

| | | | |
|--------|---------|------------|------------------|
| Header | Message | Check code | Delimiter |
|--------|---------|------------|------------------|

Packet delimiter code; ASCII CR(0Dh).

5. Message type

5.1 Get current Parameter from a monitor.

| STX | OP code page | | OP code | | ETX |
|-----------------|----------------------------------|----|----------------------------------|----|-----------------|
| | Hi | Lo | Hi | Lo | |
| 1 st | 2 nd -3 rd | | 4 th -5 th | | 6 th |

Send this message when you want to get the status of a monitor.

For the status that you want to get, specify the "OP code page" the "OP code", refer to "Appendix A. Operation code table".

1stbyte) STX: Start of Message

ASCII STX (02h)

2nd-3rdbytes) OP code page: Operation code page.

Specify the "OP code page" for the control which you want to get the status.

Refer to "Appendix A Operation code table" for each item.

OP code page data must be encoded to ASCII characters.

Ex.) The byte data 02h must be encoded to ASCII characters '0' and '2' (30h and 32h).

OP code page 02h -> OP code page (Hi) = ASCII '0' (30h)

OP code page (Lo) = ASCII '2' (32h)

Refer to Operation code table. (Appendix A)

4th-5thbytes) OP code: Operation code

Refer to "Appendix A Operation code table" for each item.

OP code data must be encoded to ASCII characters.

Ex.) The byte data 3Ah must be encoded to ASCII characters '3' and 'A' (33h and 41h).

OP code 3Ah -> OP code (Hi) = ASCII '3' (33h)

OP code (Lo) = ASCII 'A' (41h)

Refer to Operation code table.

6thbyte) ETX: End of Message

ASCII ETX (03h)

5.2 "Get parameter" reply

| STX | Result | | OP code page | | OP code | | Type | | Max value | | | | Current Value | | | | ETX |
|-----------------|----------------------------------|----|----------------------------------|----|----------------------------------|----|----------------------------------|----|------------------------------------|--|--|-----|------------------------------------|--|--|-----|------------------|
| | Hi | Lo | Hi | Lo | Hi | Lo | Hi | Lo | MSB | | | LSB | MSB | | | LSB | |
| 1 st | 2 nd -3 rd | | 4 th -5 th | | 6 th -7 th | | 8 th -9 th | | 10 th -13 th | | | | 14 th -17 th | | | | 18 th |

The monitor replies with a current value and the status of the requested item (operation code).

1stbyte) STX: Start of Message

ASCII STX (02h)

2nd-3rdbytes) Result code.

These bytes indicate a result of the requested commands as follows,

00h: No Error.

01h: Unsupported operation with this monitor or unsupported operation under current condition.

This result code from the monitor is encoded to ASCII characters.

Ex.) The byte data 01h is encoded to ASCII character '0' and '1' (30h and 31h).

4th-5thbytes) OP code page: Operation code page.

These bytes indicate a replying item's OP code page.

This returned value from the monitor is encoded to ASCII characters.

Ex.) The byte data 02h is encoded to ASCII character '0' and '2' (30h and 32h).

Refer to the operation code table.

6th-7thbytes) OP code: Operation code

These bytes indicate a replying item's OP code.

This returned value from the monitor is encoded to ASCII characters.

Refer to the operation code table.

Ex.) The byte data 1Ah is encoded to ASCII character '1' and 'A' (31h and 41h).

8th-9thbytes) Type: Operation type code

00h: Set parameter

01h: Momentary

Like the Auto Setup function which automatically changes the parameter.

This returned value from the monitor is encoded to ASCII characters.

Ex.) The byte data 01h is encoded to ASCII character '0' and '1' (30h and 31h).

10th-13thbytes) Max. value: Maximum value which monitor can accept. (16bits)

This returned value from the monitor is encoded to ASCII characters.

Ex.) '0','1','2' and '3' means 0123h (291)

14th-17thbytes) Current Value: (16bits)

This returned value from the monitor is encoded to ASCII characters.

Ex.) '0','1','2' and '3' means 0123h (291)

18thbyte) ETX: End of Message

ASCII ETX (03h)

5.3 Set parameter

| STX | OP code page | | OP code | | Set Value | | | ETX |
|-----------------|----------------------------------|----|----------------------------------|----|----------------------------------|--|-----|------------------|
| | Hi | Lo | Hi | Lo | MSB | | LSB | |
| 1 st | 2 nd -3 rd | | 4 th -5 th | | 6 th -9 th | | | 10 th |

Send this message to change monitor's adjustment and so on.

The controller requests a monitor to change value.

1stbyte) STX: Start of Message

ASCII STX (02h)

2nd-3rdbytes) OP code page: Operation code page

This OP code page data must be encoded to ASCII characters.

Ex.) The byte data 02h must be encoded to ASCII '0' and '2' (30h and 32h).

Refer to the Operation code table.

4th-5thbytes) OP code: Operation code

This OP code data must be encoded to ASCII characters.

Ex.) OP code 1Ah -> OP code (Hi) = ASCII '1' (31h)

OP code (Lo) = ASCII 'A' (41h)

Refer to the Operation code table.

6th-9thbytes) Set value: (16bit)

This data must be encoded to ASCII characters.

Ex.) 0123h -> 1st(MSB) = ASCII '0' (30h)

2nd = ASCII '1' (31h)

3rd = ASCII '2' (32h)

4th(LSB) = ASCII '3' (33h)

10thbyte) ETX: End of Message

ASCII ETX (03h)

5.4 "Set parameter" reply

| STX | Result | | OP code page | | OP code | | Type | | Max value | | | Requested setting Value | | | ETX |
|-----------------|----------------------------------|----|----------------------------------|----|----------------------------------|----|----------------------------------|----|------------------------------------|--|-----|------------------------------------|--|-----|------------------|
| | Hi | Lo | Hi | Lo | Hi | Lo | Hi | Lo | MSB | | LSB | MSB | | LSB | |
| 1 st | 2 nd -3 rd | | 4 th -5 th | | 6 th -7 th | | 8 th -9 th | | 10 th -13 th | | | 14 th -17 th | | | 18 th |

The Monitor echoes back the parameter and status of the requested operation code.

1stbyte) STX: Start of Message

ASCII STX (02h)

2nd-3rdbytes) Result code

ASCII '0''0' (30h, 30h): No Error.

ASCII '0''1' (30h, 31h): Unsupported operation with this monitor or unsupported operation under current condition.

4th-5thbytes) OP code page: Echoes back the Operation code page for confirmation.

Reply data from the monitor is encoded to ASCII characters.

Ex.) OP code page 02h -> OP code page = ASCII '0' and '2' (30h and 32h)

Refer to Operation code table.

6th-7thbytes) OP code: Echoes back the Operation code for confirmation.

Reply data from the monitor is encoded to ASCII characters.

Ex.) OP code 1Ah -> OP code (Hi) = ASCII '1' (31h)

OP code (Lo) = ASCII 'A' (41h)

Refer to Operation code table

8th-9thbytes) Type: Operation type code

ASCII '0''0' (30h, 30h): Set parameter

ASCII '0''1' (30h, 31h): Momentary

Like Auto Setup function, that automatically changes the parameter.

10th-13thbytes) Max. value: Maximum value that monitor can accept. (16bits)

Reply data from the monitor is encoded to ASCII characters.

Ex.) '0''1''2''3' means 0123h (291)

14th-17thbytes) Requested setting Value: Echoes back the parameter for confirmation. (16bits)

Reply data from the monitor is encoded to ASCII characters.

Ex.) '0''1''2''3' means 0123h (291)

18thbyte) ETX: End of Message

ASCII ETX (03h)

5.5 Commands

"Command message format" depends on each command. Some commands are shown with usage. Refer to section 7 to 13.

5.5.1 Save Current Settings.

The controller requests for the monitor to store the adjusted value.

| | | | |
|-----|--------------|-----|-----|
| STX | Command code | | ETX |
| | '0' | 'C' | |

- Send "OC" (30h, 43h) as Save current settings command.
- Complete "Save Current setting" command packet as follows;

ASCII: 01h-30h-41h-30h-41h-30h-34h-02h-30h-43h-03h-CHK-0Dh

SOH-'0'-'A'-'0'-'A'-'0'-'4'-STX-'0'-'C'-ETX-CHK- CR

The monitor replies the packet for confirmation as follows;

SOH-'0'-'0'-'A'-'B'-'0'-'6'-STX-'0'-'0'-'0'-'C'-ETX-CHK- CR

5.5.2 Get Timing Report and Timing reply.

The controller requests the monitor to report the displayed image timing.

| | | | |
|-----|--------------|-----|-----|
| STX | Command code | | ETX |
| | '0' | '7' | |

- Send "07" (30h, 37h) as Get Timing Report command.
- Complete "Get Timing Report" command packet as follows;

ASCII: 01h-30h-41h-30h-41h-30h-34h-02h-30h-37h-03h-CHK-0Dh

SOH-'0'-'A'-'0'-'A'-'0'-'4'-STX-'0'-'7'-ETX-CHK- CR

The monitor replies status as the following format;

| | | | | | | | | | | | |
|-----|---------|-----|----|----|---------|--|-----|---------|--|-----|-----|
| STX | Command | | SS | | H Freq. | | | V Freq. | | | ETX |
| | '4' | 'E' | Hi | Lo | MSB | | LSB | MSB | | LSB | |

- SS: Timing status byte
 - Bit 7 = 1: Sync Frequency is out of range.
 - Bit 6 = 1: Unstable count
 - Bit 5-2 Reserved (Don't care)
 - Bit 1 1:Positive Horizontal sync polarity.
0:Negative Horizontal sync polarity.
 - Bit 0 1:Positive Vertical sync polarity.
0:Negative Vertical sync polarity.
- H Freq: Horizontal Frequency in unit 0.01kHz
- V Freq: Vertical Frequency in unit 0.01Hz
 - Ex.) When H Freq is '1'2'A'9' (31h, 32h, 41h, 39h), it means 47.77kHz.

5.5.3 NULL Message

| | | | |
|-----|--------------|-----|-----|
| STX | Command code | | ETX |
| | 'B' | 'E' | |

The NULL message returned from the monitor is used in the following cases;

- To tell the controller that the monitor does not have any answer to give to the host (not ready or not expected)
- A null message will be returned by the monitor if the "Start Proof of Play" command is sent and the monitor has already started Proof of Play.
- A null message will be returned by the monitor if the "Stop Proof of Play" command is sent and the monitor has not started Proof of Play.
- Complete "NULL Message" command packet as follows;
01h-30h-30h-41h-42h-30h-34h-02h-42h-45h-03h-CHK-0Dh
SOH-'0'-'0'-'A'-'B'-'0'-'4'-STX-'B'-'E'-ETX-CHK- CR

IV. Control Commands

6. Typical procedure example

The following is a sample of procedures to control the monitor, these are examples of "Get parameter", "Set parameter" and "Save current settings".

6.1. How to change the "Backlight" setting.

Step 1. The controller requests the Monitor to reply with the current brightness setting and capability to support this operation. (Get parameter)

| Header | Message | Check code | Delimiter |
|------------------------------------|-------------------------|------------|-----------|
| SOH-'0'-Monitor ID-'0'-'C'-'0'-'6' | STX-'0'-'0'-'1'-'0'-ETX | BCC | CR |

Header

SOH (01h): Start of Header
'0' (30h): Reserved
Monitor ID: Specify the Monitor ID from which you want to get a value.
Ex.) If Monitor ID is '1', specify 'A'.
'0' (30h): Message sender is the controller.
'C' (43h): Message type is "Get parameter command".
'0'-'6' (30h, 36h): Message length is 6 bytes.

Message

STX (02h): Start of Message
'0'-'0' (30h, 30h): Operation code page number is 0.
'1'-'0' (31h, 30h): Operation code is 10h (in the OP code page 0).
ETX (03h): End of Message

Check code

BCC: Block Check Code
Refer to the section 4.3 "Check code" for a BCC calculation.

Delimiter

CR (0Dh): End of packet

Step 2. The monitor replies with current Backlight setting and capability to support this operation.

| Header | Message | Check code | Delimiter |
|------------------------------------|---|------------|-----------|
| SOH-'0'-'0'-Monitor ID-'D'-'1'-'2' | STX-'0'-'0'-'0'-'0'-'1'-'0'-'0'-'0'-'0'-'0'-'6'-'4'-'0'-'0'-'3'-'2'-ETX | BCC | CR |

Header

SOH (01h): Start of Header
'0' (30h): Reserved
'0' (30h): Message receiver is the controller.
Monitor ID: Indicate a replying Monitor ID.
Ex.) When this byte is set to 'A', the replying Monitor ID is '1'.
'D' (44h): Message Type is "Get parameter reply".
'1'-'2' (31h, 32h): Message length is 18 bytes.

Message

STX (02h): Start of Message
'0'-'0' (30h, 30h): Result code. No error.
'0'-'0' (30h, 30h): Operation code page number is 0.
'1'-'0' (31h, 30h): Operation code is 10h (in the page 0).
'0'-'0' (30h, 30h): This operation is "Set parameter" type.
'0'-'0'-'6'-'4' (30h, 30h, 36h, 34h): Backlight max value is 100(0064h).
'0'-'0'-'3'-'2' (30h, 30h, 33h, 32h): Current Backlight setting is 50(0032h) .
ETX (03h): End of Message

Check code

BCC: Block Check Code
Refer to the section 4.3 "Check code" for a BCC calculation.

Delimiter
CR (0Dh): End of packet

Step 3. The controller request the monitor to change the Backlight setting

| Header | Message | Check code | Delimiter |
|------------------------------------|---|------------|-----------|
| SOH-'0'-Monitor ID-'0'-'E'-'0'-'A' | STX-'0'-'0'-'1'-'0'-'0'-'0'-'5'-'0'-ETX | BCC | CR |

Header

SOH (01h): Start of Header
'0' (30h): Reserved
Monitor ID: Specify the Monitor ID of which you want to change a setting.
Ex.) If Monitor ID is '1', specify 'A'.
'0' (30h): Message sender is the controller.
'E' (45h): Message Type is "Set parameter command".
'0'-'A' (30h, 41h): Message length is 10 bytes.

Message

STX (02h): Start of Message
'0'-'0' (30h, 30h): Operation code page number is 0.
'1'-'0' (31h, 30h): Operation code is 10h (in the page 0).
'0'-'0'-'5'-'0' (30h, 30h, 35h, 30h): Set Backlight setting 80(0050h).
ETX (03h): End of Message

Check code

BCC: Block Check Code
Refer to the section 4.3 "Check code" for a BCC calculation.

Delimiter

CR (0Dh): End of packet

Step 4. The monitor replies with a message for confirmation.

| Header | Message | Check code | Delimiter |
|---------------------------------------|---|------------|-----------|
| SOH-'0'-'0'- Monitor ID - 'F'-'1'-'2' | STX-'0'-'0'-'0'-'0'-'1'-'0'-'0'-'0'-'0'-'0'-'6'-'4'-'0'-'0'-'5'-'0'-ETX | BCC | CR |

Header

SOH (01h): Start of Header
'0' (30h): Reserved
'0' (30h): Message receiver is the controller.
Monitor ID: Indicate a replying Monitor ID.
Ex.) When this byte is set to 'A', the replying Monitor ID is '1'.
'F' (46h): Message Type is "Set parameter reply".
'1'-'2' (31h, 32h): Message length is 18 bytes.

Message

STX (02h): Start of Message
'0'-'0' (30h, 30h): Result code. No error.
'0'-'0' (30h, 30h): Operation code page number is 0.
'1'-'0' (31h, 30h): Operation code is 10h (in the page 0).
'0'-'0' (30h, 30h): This operation is "Set parameter" type.
'0'-'0'-'6'-'4' (30h, 30h, 36h, 34h): Backlight max value is 100(0064h).
'0'-'0'-'5'-'0' (30h, 30h, 35h, 30h): Received a Backlight setting was 80(0050h) .
ETX (03h): End of Message

Check code

BCC: Block Check Code
Refer to the section 4.3 "Check code" for a BCC calculation.

Delimiter

CR (0Dh): End of packet

- Repeat Step 1 and Step 2, if you need to check the Backlight setting. (Recommended)
- Step 5. Request the monitor to store the Backlight setting. (Save Current Settings Command)

| Header | Message | Check code | Delimiter |
|------------------------------------|------------------|------------|-----------|
| SOH-'0'-Monitor ID-'0'-'A'-'0'-'4' | STX-'0'-'C'-'ETX | BCC | CR |

Header

SOH (01h): Start of Header
 '0' (30h): Reserved
 Monitor ID: Specify the Monitor ID which you want to store the setting.
 Ex.) If Monitor ID is '1', specify 'A'.
 '0' (30h): Message sender is the controller.
 'A' (41h): Message type is "Command".
 '0'-'4' (30h, 34h): Message length is 4 bytes.

Message

STX (02h): Start of Message
 '0'-'C' (30h, 43h): Command code is 0Ch as "Save current settings".
 ETX (03h): End of Message

Check code

BCC: Block Check Code
 Refer to the section 4.3 "Check code" for a BCC calculation.

Delimiter

CR (0Dh): End of packet

6.2. How to read the measurement value of the built-in temperature sensors.

MultiSync X841UHD, X981UHD, X651UHD have three built-in temperature sensors.

The controller can monitor inside temperatures by using those sensors with external control.

The following shows the procedure for reading the temperatures from the sensors.

Step 1. Select a temperature sensor which you want to read.

| Header | Message | Check code | Delimiter |
|--|---|------------|-----------|
| SOH-'0'-Monitor ID- '0'-'E'-'0'-'A' | STX-'0'-'2'-'7'-'8'- '0'-'0'-'0'-'1'-ETX | BCC | CR |

Header

SOH (01h): Start of Header
 '0' (30h): Reserved
 Monitor ID: Specify the Monitor ID which you want to get a value.
 Ex.) If Monitor ID is '1', specify 'A'.
 '0' (30h): Message sender is the controller.
 'E' (45h): Message Type is "Set parameter command".
 '0'-'A' (30h, 41h): Message length is 10 bytes.

Message

STX (02h): Start of Message
 '0'-'2' (30h, 32h): Operation code page number is 2.
 '7'-'8' (37h, 38h): Operation code is 78h (on page 2).
 '0'-'0'-'0'-'1' (30h, 30h, 30h, 31h): Select the temperature sensor #1 (01h).
 00h: No meaning
 01h: Sensor #1
 02h: Sensor #2
 03h: Sensor #3
 ETX (03h): End of Message

Check code

BCC: Block Check Code
 Refer to the section 4.3 "Check code" for a BCC calculation.

Delimiter

CR (0Dh): End of packet

Step 2. The monitor replies for confirmation.

| Header | Message | Check code | Delimiter |
|--|---|------------|-----------|
| SOH-'0'-'0'-Monitor ID- 'F'-'1'-'2' | STX-'0'-'0'-'0'-'2'-'7'-'8'-'0'-'0'- '0'-'0'-'0'-'3'-'0'-'0'-'0'-'1'-ETX | BCC | CR |

Header

SOH (01h): Start of Header
 '0' (30h): Reserved
 '0' (30h): Message receiver is the controller.
 Monitor ID: Indicates a replying Monitor ID.
 Ex.) When this byte is set to 'A', the replying Monitor ID is '1'.
 'F' (46h): Message Type is "Set parameter reply".
 '1'-'2' (31h, 32h): Message length is 18 bytes.

Message

STX (02h): Start of Message
 '0'-'0' (30h, 30h): Result code. No error.
 '0'-'2' (30h, 32h): Operation code page number is 2.
 '7'-'8' (37h, 38h): Operation code is 78h (in the page 2).
 '0'-'0' (30h, 30h): This operation is "Set parameter" type.

'0'-'0'-'0'-'3' (30h, 30h, 30h, 33h): Number of temperature sensors are 3 (0003h).
 '0'-'0'-'0'-'1' (30h, 30h, 30h, 31h): temperature sensor is #1.
 ETX (03h): End of Message

Check code

BCC: Block Check Code
 Refer to the section 4.3 "Check code" for a BCC calculation.

Delimiter

CR (0Dh): End of packet

Step 3. The controller requests the monitor to send the temperature from the selected sensor.

| Header | Message | Check code | Delimiter |
|------------------------------------|-------------------------|------------|-----------|
| SOH-'0'-Monitor ID-'0'-'C'-'0'-'6' | STX-'0'-'2'-'7'-'9'-ETX | BCC | CR |

Header

SOH (01h): Start of Header
 '0' (30h): Reserved
 Monitor ID: Specify the Monitor ID which you want to get a value.
 Ex.) If Monitor ID is '1', specify 'A'.
 '0' (30h): Message sender is the controller.
 'C' (43h): Message Type is "Get parameter".
 '0'-'6' (30h, 36h): Message length is 6 bytes.

Message

STX (02h): Start of Message
 '0'-'2' (30h, 32h): Operation code page number is 2.
 '7'-'9' (37h, 39h): Operation code is 79h (in the page 2).
 ETX (03h): End of Message

Check code

BCC: Block Check Code
 Refer to the section 4.3 "Check code" for a BCC calculation.

Delimiter

CR (0Dh): End of packet

Step 4. The monitor replies a temperature of selected sensor.

| Header | Message | Check code | Delimiter |
|------------------------------------|---|------------|-----------|
| SOH-'0'-'0'-Monitor ID-'D'-'1'-'2' | STX-'0'-'0'-'0'-'2'-'7'-'9'-'0'-'0'-'F'-'F'-'F'-'F'-'0'-'0'-'3'-'2'-ETX | BCC | CR |

Header

SOH (01h): Start of Header
 '0' (30h): Reserved
 '0' (30h): Message receiver is the controller.
 Monitor ID: Indicate a replying Monitor ID.
 Ex.) When this byte is set to 'A', the replying Monitor ID is '1'.
 'D' (44h): Message Type is "Get parameter reply".
 '1'-'2' (31h, 32h): Message length is 18 bytes.

Message

STX (02h): Start of Message
 '0'-'0' (30h, 30h): Result code. No error.
 '0'-'2' (30h, 32h): Operation code page number is 2.
 '7'-'9' (37h, 39h): Operation code is 79h (in the page 2).
 '0'-'0' (30h, 30h): This operation is "Set parameter" type.
 'F'-'F'-'F'-'F' (46h, 46h, 46h, 46h): Maximum value.
 '0'-'0'-'3'-'2' (30h, 30h, 33h, 32h): The temperature is 25 degrees Celsius.

Readout value is 2's complement.

| Temperature [Celsius] | Readout value | |
|-----------------------|---------------------|-------------|
| | Binary | Hexadecimal |
| +125.0 | 0000 0000 1111 1010 | 00FAh |
| + 25.0 | 0000 0000 0011 0010 | 0032h |
| + 0.5 | 0000 0000 0000 0001 | 0001h |
| 0 | 0000 0000 0000 0000 | 0000h |
| - 0.5 | 1111 1111 1111 1111 | FFFFh |
| - 25.0 | 1111 1111 1100 1110 | FFCEh |
| - 55.0 | 1111 1111 1001 0010 | FF92h |

ETX (03h): End of Message

Check code

BCC: Block Check Code

Refer to the section 4.3 "Check code" for a BCC calculation.

Delimiter

CR (0Dh): End of packet

6.3. Operation Code (OP code) Table

| | Item | OP code page | OP code | Parameter | Remarks |
|---------|----------------------------|--------------|---|---|-----------|
| PICTURE | BACKLIGHT | 00h | 10h | 0: dark 100(64h): bright | |
| | CONTRAST | 00h | 12h | 0: low 100(64h): high | |
| | SHARPNESS | 00h | 8Ch | 0: dull 24(18h): sharp | |
| | BRIGHTNESS | 00h | 92h | 0: dark 100(64h): bright | |
| | COLOR TEMPERATURE | 00h | 54h | 0:2600K 74(4Ah):10000K | 100K/step |
| | COLOR TEMPERATURE (CUSTOM) | 00h | 14h | 9: 10000K 11(0Bh): CUSTOM | |
| | R GAIN | 00h | 16h | 0: Dark 255(FFh): Bright | |
| | B GAIN | 00h | 18h | 0: Dark 255(FFh): Bright | |
| | G GAIN | 00h | 1Ah | 0: Dark 255(FFh): Bright | |
| | COLOR CONTROL | 00h | RED: 9Bh YELLOW: 9Ch GREEN: 9Dh CYAN: 9Eh BLUE: 9Fh MAGENTA: A0h | 0: 100(64h):(center) 200(C8h): | |
| | GAMMA CORRECTION | 02h | 68h | 0: No mean 1: NATIVE 4: 2.2 8: 2.4 7: S GAMMA 5: DICOM SIM. 6: PROGRAMABLE1 13(0Dh): PROGRAMABLE2 14(0Eh): PROGRAMABLE3 | |
| | UHD UPSCALING | 11h | 09h | 0: No mean 1: LOW 2: MIDDLE 3: HIGH | |

| Item | OP code page | OP code | Parameter | Remarks | |
|------------------------|--------------|---------|--|---|--|
| PICTURE MODE | 02h | 1Ah | 0: No mean 1: sRGB 3: HIGHBRIGHT 4: STANDARD 5: CINEMA 8: CUSTOM1 9: CUSTOM2 13(0Dh): SVE-1 SETTING 14(0Eh): SVE-2 SETTING 15(0Fh): SVE-3 SETTING 16(10h): SVE-4 SETTING 17(11h): SVE-5 SETTING | sRGB: PC mode only CINEMA: A/V mode only | |
| SVE- (1-5) SETTINGS | PRESET | 10h | 51h | 0: No mean 1: sRGB 2: Adobe RGB SIM 3: DCI SIM 4: REC-Bt709 5: HIGHBRIHGT 6: FULL 7: DICOM SIM 8: PROGRAMMABLE1 9: PROGRAMMABLE2 10(0Ah): PROGRAMMABLE3 11(0Bh): PROGRAMMABLE4 12(0Ch): PROGRAMMABLE5 13(0Dh): eciRGB v2 | |
| | LUMINANCE | 02h | B3h | 0(0%): Dark 600(0258h)(100%): Bright Note: Conversion equation Value = (OSD Value/100) * (600-40)+40 | |
| | WHITE | 00h | 54h | 0:2600K 74(4Ah):10000K | |
| | | 00h | 14h | 2: NAVIVE 11(0Bh): CUSTOM | |
| | WHITE x | 10h | 52h | 250(00FAh): 0.250 480(01E0h): 0.480 | |
| | WHITE y | 10h | 53h | 250(00FAh): 0.250 480(01E0h): 0.480 | |
| | GAMMA | 02h | 68h | 0: No mean 5: DICOM SIM. 9: CST 11(0Bh): sRGB 12(0Ch): L STAR | |
| | CUSTOM VALUE | 02h | E8h | 0: 0.5 (MIN) 350(015Eh): 4.0 (MAX) | |
| | BLACK | 10h | 54h | 1: 0.1 (MIN) 50(32h): 5.0 (MAX) | |
| | RED x | 10h | 55h | 550(0226h): 0.550 800(0320h): 0.800 | |
| | RED y | 10h | 56h | 200(00C8h): 0.200 400(0190h): 0.400 | |
| | GREEN x | 10h | 57h | 100(0064h): 0.100 350(015Eh): 0.350 | |

| Item | | OP code page | OP code | Parameter | Remarks | |
|--------|------------------|--------------|---------|--|--|--|
| | GREEN y | 10h | 58h | 500(01F4h) : 0.500 900(0384h) : 0.900 | | |
| | BLUE x | 10h | 59h | 0: 0.000 250(00FAh) : 0.250 | | |
| | BLUE y | 10h | 5Ah | 0: 0.000 150(0096h) : 0.150 | | |
| | COLOR VISION EMU | 10h | 5Bh | 0: No mean 1: OFF 2: P 3: D 4: T 5: GRAY | | |
| | UNIFORMITY | 02h | EEh | 0: OFF 5 | | |
| | METAMERISM | 10h | 5Ch | 0: No mean 1: OFF 2: ON | | |
| | RESET (PICTURE) | 02h | CBh | 0: No mean 2: Reset Picture category | Momentary | |
| ADJUST | ASPECT | 02h | 70h | 0: No mean 1: NORMAL 2: FULL 3: WIDE 4: ZOOM 6: DYNAMIC 7: 1:1 | Wide: Dynamic A/V mode only | |
| | Zoom Control | ZOOM | 11h | 2Ch | 0-89(59h) : No mean 90(5Ah) : 90% 91(5Bh) : 91% 100(64h) : 100% 300(12Ch) : 300% | The following commands can also be used. OP code page 02h OP code 6Fh Parameter 0: No mean 1: 100% 2: 101% 201(C9h) : 300% |
| | | H ZOOM | 11h | 2Dh | 0-89(59h) : No mean 90(5Ah) : 90% 91(5Bh) : 91% 100(64h) : 100% 300(12Ch) : 300% | The following commands can also be used. OP code page 02h OP code 6Ch Parameter 0: No mean 1: 100% 2: 101% 201(C9h) : 300% |

| Item | | OP code page | OP code | Parameter | Remarks | |
|----------------|---------------------|--------------|---------|---|---|--|
| | V ZOOM | 11h | 2Eh | 0-89(59h): No mean 90(5Ah): 90% 91(5Bh): 91% 100(64h): 100% 300(12Ch): 300% | The following commands can also be used. OP code page 02h OP code 6Dh Parameter 0: No mean 1: 100% 2: 101% 201(C9h): 300% | |
| | H POS | 02h | CCh | 0: Left side 200(C8h): Right side | | |
| | V POS | 02h | CDh | 0: Down side 200(C8h): Up side | | |
| IMAGE FLIP | | 02h | D7h | 0: No mean 1: NONE 2: H FLIP 3: V FLIP 4: 180 ROTATE | | |
| OSD FLIP | | 10h | B8h | 0: No mean 1: OFF 2: ON | | |
| RESET (ADJUST) | | 02h | CBh | 0: No mean 3: Reset Adjust category | Momentary | |
| AUDIO | VOLUME | | 00h | 62h | 0: whisper 100(64h): loud | |
| | BALANCE | | 00h | 93h | 0: Left 30(1Eh): (Center) 60(3Ch): Right | |
| | | | 00h | 94h | 0: No mean 1: MONAURAL 2: STEREO | |
| | TREBLE | | 00h | 8Fh | 0: Min. 6: (Center) 12(0Ch): Max. | |
| | BASS | | 00h | 91h | 0: Min. 6: (Center) 12(0Ch): Max. | |
| | SURROUND | | 02h | 34h | 0: No mean 1: OFF 2: ON | |
| | MULTI PICTURE AUDIO | | 10h | 80h | 0: No mean 3: PICTURE1 4: PICTURE2 5: PICTURE3 6: PICTURE4 | |
| | LINE OUT | | 10h | 81h | 0: No mean 1: FIXED 2: VARIABLE | |

| | Item | OP code page | OP code | Parameter | Remarks | |
|-----------------------|-------------------------------|--------------|---------------------------|---|---|-----------|
| | AUDIO INPUT | 02h | 2Eh | 0: No mean 1: LINE IN 4: HDMI 6: OPTION 7: DPORT 8: DPORT2 10(0Ah): HDMI2 11(0Bh): HDMI3 12(0Ch): HDMI4 | | |
| | AUDIO DELAY | 10h | CAh | 0: No mean 1: OFF 2: ON | | |
| | DELAY TIME | 10h | CBh | 0: (small) 100(64h): (large) | | |
| | RESET (AUDIO) | 02h | CBh | 0: No mean 4: Reset Audio category | Momentary | |
| SCHEDULE | OFF TIMER | 02h | 2Bh | 0: Off 1: 1 hour 24(18h): 24 hours | 1 hour/step | |
| | SCHEDULE | ENABLE | 02h | E5h | 0: No mean 1: No.1 Enable 7: No.7 Enable | |
| | | DISABLE | 02h | E6h | 0: No mean 1: No.1 Disable 7: No.7 Disable | |
| | SCHEDULE SETTINGS | | Refer to section 10 | | | |
| | DATE & TIME | | Refer to section 9 | | | |
| | DAYLIGHT SAVING | | Refer to section 9 and 15 | | | |
| | RESET (SCHEDULE) | | 02h | CBh | 0: No mean 5: Reset Schedule category | Momentary |
| MULTI PICTURE CONTROL | KEEP MULTI PICTURE MODE | 10h | 82h | 0: No mean 1: OFF 2: ON | | |
| | MULTI PICTURE | 02h | 72h | 0: No mean 1: Off 2: PIP 5: PBP (PBP1, PBP2, PBP3) | | |
| | PICTURE NUMBER / PICTURE MODE | 10h | B5h | If MULTI PICTURE is set PIP 0: No mean 2: 2WINDOWS, PIP 3: 3WINDOWS, PIP If MULTI PICTURE is set PBP 0: No mean 1: 2WINDOWS, PBP1 3: 3WINDOWS, PBP1 4: 3WINDOWS, PBP2 5: 3WINDOWS, PBP3 6: 4WINODWS, PBP1 | | |
| | ACTIVE PICTURE | 11h | 0Bh | 0: No mean 1: PICTURE1 2: PICTURE2 3: PICTURE3 4: PICTURE4 | | |
| | ACTIVE FRAME | 11h | 0Dh | 0: No mean 1: OFF 2: ON | | |

| Item | | OP code page | OP code | Parameter | Remarks | |
|------------------|------------|--------------|---------|--|--|--|
| INPUT SELECT | PICTURE1 | 11h | 0Eh | 0: No mean 3: DVI1 4: DVI2 13(0Dh): OPTION 15(0Fh): DPORT 16(10h): DPORT2 17(11h): HDMI1 18(12h): HDMI2 130(82h): HDMI3 131(83h): HDMI4 | | |
| | PICTURE2 | 11h | 0Fh | | | |
| | PICTURE3 | 11h | 10h | | | |
| | PICTURE4 | 11h | 11h | | | |
| PICTURE SIZE | | 10h | B9h | 0 (small) 80 (large) | | |
| PICTURE POSITION | X | 02h | 74h | 0: left 100(64h): right | | |
| | Y | 02h | 75h | 0: top 100(64h): bottom | | |
| PICTURE ASPECT | | 10h | 83h | 0: No mean 1: NORMAL 2: FULL 3: WIDE 4: ZOOM | | |
| ROTATE | ROTATE ALL | 11h | 16h | 0: No mean 1: OFF 2: ON | | |
| | PICTURE1 | 11h | 12h | | | |
| | PICTURE2 | 11h | 13h | | | |
| | PICTURE3 | 11h | 14h | | | |
| TEXT TICKER | MODE | 10h | 08h | 0: No mean 1: OFF 2: HORIZONTAL 3: VERTICAL | | |
| | POSITION | 10h | 09h | 0: Top/Left 100(64h): Bottom/Right | | |
| | SIZE | 10h | 0Ah | 0-1: Do not set. 2: Narrow(2/24) 8: Wide(8/24) | | |
| | DETECT | 10h | 0Ch | 0: No mean 1: AUTO 2: OFF | | |
| | PICTURE1 | | 11h | 2Ah | 0: No mean 3: DVI1 4: DVI2 13(0Dh): OPTION 15(0Fh): DPORT 16(10h): DPORT2 17(11h): HDMI1 18(12h): HDMI2 130(82h): HDMI3 131(83h): HDMI4 | |
| | | PICTURE2 | 11h | 2Bh | | |
| RESET (PIP) | | 02h | CBh | 0: No mean 6: Reset PIP Category | Momentary | |

| | Item | OP code page | OP code | Parameter | Remarks | |
|---------------|---------------------|--------------|--|---|--|--|
| OSD | LANGUAGE | 00h | 68h | 0: No mean 1: ENGLISH 2: GERMAN 3: FRENCH 4: SPANISH 5: JAPANESE 6: ITALIAN 7: SWEDISH 9: RUSSIAN 14(0Eh): CHINESE | OSD Language | |
| | MENU DISPLAY TIME | 00h | FCh | 0-1: Do not set. 2: 10s 3: 15s 48(30h): 240s | 5sec/step | |
| | OSD POSITION | X | 02h | 38h | 0: Left 255(FFh): Right | |
| | | Y | 02h | 39h | 0: Down 255(FFh): Up | |
| | INFORMATION OSD | 02h | 3Dh | 0:Disable information OSD 3-10(0Ah): OSD timer [seconds] | | |
| | MONITOR INFORMATION | MODEL NAME | Refer to section 12 | | | |
| | | SERIAL | Refer to section 12 | | | |
| | | FIRMWARE1 | Refer to section 16 | | | |
| | | FIRMWARE2 | | | | |
| | | FIRMWARE3 | | | | |
| | | FIRMWARE4 | | | | |
| | CARBON SAVINGS | 10h | 10h (g) /11h (kg) | 0 - 999(3E7h) (g) 0 - 65535(FFFFh) (kg) | Read Only | |
| | CARBON USAGE | 10h | 26h (g) /27h (kg) | 0 - 999(3E7h) (g) 0 - 65535(FFFFh) (kg) | Read Only | |
| | OSD TRANSPARENCY | 02h | B8h | 0: No mean 1: OFF 2: ON | | |
| | OSD ROTATION | 02h | 41h | 0: Landscape 1: Rotated | | |
| INPUT NAME | Refer to section 18 | | | | | |
| NAME RESET | | | | | | |
| MEMO | 10h | BAh | 0: No mean 1: Display a Memo 2: Undisplay a Memo | | | |
| RESET (OSD) | 02h | CBh | 0: No mean 7: Reset OSD category | Momentary | | |
| MULTI DISPLAY | MONITOR ID | 02h | 3Eh | 1-100:ID | | |
| | GROUP ID | 10h | 7Fh | 0: No assignment 1: Group A 2: Group B 3: Group AB 4: Group C 5: Group AC 1023(3FFh):Group ABCDEFGHIJ | Bit0:Group A Bit1:Group B Bit2:Group C Bit3:Group D Bit4:Group E Bit5:Group F Bit6:Group G Bit7:Group H Bit8:Group I Bit9:Group J | |

| | Item | OP code page | OP code | Parameter | Remarks | |
|-------------|-----------------------|--|---------------------|---|---|--|
| | IR LOCK SETTING | MODE SELECT | 10h | D4h | 0: No mean 1: UNLOCK 2: ALL LOCK 3: CUSTOM LOCK | The following commands can also be used. OP code page 02h OP code 3Fh Parameter 0: No mean 1: NORMAL 4: LOCK |
| | | POWER | 10h | D5h | 0: No mean 1: UNLOCK 2: LOCK | |
| | | VOLUME | 10h | D6h | 0: No mean 1: UNLOCK 2: LOCK | |
| | | MIN VOL | 10h | D7h | 0 (whisper) 100(64h) (laud) | |
| | | MAX VOL | 10h | D8h | 0 (whisper) 100(64h) (laud) | |
| | | INPUT | 10h | D9h | 0: No mean 1: UNLOCK 2: LOCK | |
| | | UNLOCK SELECT | 10h | DAh | 0: No mean 3: DVI1 4: DVI2 13(0Dh): OPTION 15(0Fh): DPORT 16(10h): DPORT2 17(11h): HDMI1 18(12h): HDMI2 130(82h): HDMI3 131(83h): HDMI4 132(84h): PRESET1 133(85h): PRESET2 134(86h): PRESET3 | |
| | | | 10h | DBh | 15(0Fh): DPORT 16(10h): DPORT2 17(11h): HDMI1 18(12h): HDMI2 130(82h): HDMI3 131(83h): HDMI4 132(84h): PRESET1 133(85h): PRESET2 134(86h): PRESET3 | |
| | | | 10h | DCh | 131(83h): HDMI4 132(84h): PRESET1 133(85h): PRESET2 134(86h): PRESET3 | |
| | POWER ON DELAY | 02h | D8h | 0: Off (0sec) 50(32h): 50sec | | |
| | LINK TO ID | 10h | BCh | 0: No mean 1: OFF 2: ON | | |
| | POWER INDICATOR | 02h | BEh | 0: No mean 1: ON 2: OFF | | |
| | SETTING COPY | Refer to section 20 | | | | |
| | RESET (MULTI DISPLAY) | 02h | CBh | 0: No mean 8: Reset Multi Display Category | Momentary | |
| | DISPLAY PROTECTION | POWER SAVE | Refer to section 19 | | | |
| HEAT STATUS | | FAN1/2/3 | 02h | 7Ah /7Bh | Select target FAN. (7Ah) 0: No mean 1: FAN#1 2: FAN#2 3: FAN#3 Read status of target FAN.(7Bh) 0: OFF 1: ON 2: ERROR | Read Only |
| BACKLIGHT | | Refer to section 11 (Self-diagnosis status read) | | | | |

| Item | | OP code page | OP code | Parameter | Remarks | |
|----------------------------|-------------------------|---------------------|---------|---|--|----------|
| | TEMPERATURE SENSOR1/2/3 | 02h | 79h | Return value is 2's complement. (0.5°C step) | Offset affects to a selected sensor. Select sensor (Page02h OPcode78h) 1 : SENSOR #1 2 : SENSOR #2 3 : SENSOR #3 | |
| FAN CONTROL | COOLING FAN | 02h | 7Dh | 0: No mean 1: AUTO 2: ON | | |
| | FAN SPEED | 10h | 3Fh | 0: No mean 1: HIGH 2: LOW | | |
| | SENSOR1 | 10h | E0h/E1h | E0h: Set centigrade 0 - 65535(FFFFh) E1h: Set offset from max. value 0 - 10(0Ah) | | |
| | SENSOR2 | 10h | E2h/E3h | E2h: Set centigrade 0 - 65535(FFFFh) E3h: Set offset from max. value 0 - 10(0Ah) | | |
| | SENSOR3 | 10h | E4h/E5h | E4h: Set centigrade 0 - 65535(FFFFh) E5h: Set offset from max. value 0 - 10(0Ah) | | |
| SCREEN SAVER | GAMMA | | 02h | DBh | 0: No mean 1: OFF 2: ON | |
| | BACKLIGHT | | 02h | DCh | 0: No mean 1: OFF 2: ON | |
| | MOTION | INTERVAL | 02h | DDh | 0: OFF(0s) 90(5Ah): 900s | 10s/step |
| | | ZOOM | 10h | 35h | 0 : 95% 5 : 100% 10(0Ah) : 105% | |
| SIDE BORDER COLOR | | 02h | DFh | 0: Black 100(64h): White | | |
| CHANGE PASSWORD | | N/A | | | | |
| SECURITY | | Refer to section 21 | | | | |
| RESET (DISPLAY PROTECTION) | | 02h | CBh | 0: No mean 9: Reset Display Protection Category | Momentary | |

| | Item | OP code page | OP code | Parameter | Remarks | |
|------------------|-----------------------------------|----------------------|---------|---|---|---|
| EXTERNAL CONTROL | MAC ADDRESS (NETWORK INFORMATION) | Refer to section 22 | | | | |
| | IP ADDRESS SETTING | N/A | | | | |
| | LAN POWER | 10h | D3h | 0: No mean 1: OFF 2: ON | | |
| | DDC/CI | 10h | BEh | 0: No mean 1: OFF 2: ON | | |
| | PING | N/A | | | | |
| | IP ADDRESS RESET | N/A | | | | |
| | RESET (EXTERNAL CONTROL) | 02h | CBh | 0: No mean 12(0Ch): Reset External Control Category | Momentary | |
| ADVANCED OPTION1 | INPUT DETECT | 02h | 40h | 0: FIRST DETECT 1: LAST DETECT 2: NONE 3: VIDEO DETECT 4: CUSTOM DETECT | | |
| | CUSTOM DETECT | PRIORITY1 | 10h | 2Eh | 0: No mean 3: DVI1 4: DVI2 13(0Dh): OPTION 15(0Fh): DPORT 16(10h): DPORT2 17(11h): HDMI1 18(12h): HDMI2 130(82h): HDMI3 131(83h): HDMI4 132(84h): PRESET1 133(85h): PRESET2 134(86h): PRESET3 | |
| | | PRIORITY2 | 10h | 2Fh | | |
| | | PRIORITY3 | 10h | 30h | | |
| | LONG CABLE COMP | DVI1 | 02h | F0h | 0: No mean 1: MODE0 2: MODE1 3: MODE2 4: MODE3 | |
| | | DVI2 | 11h | 1Ah | | |
| | | HDMI1 | 11h | 1Bh | | |
| | | HDMI2 | 11h | 1Ch | | |
| | | HDMI3 | 11h | 1Dh | | |
| | INPUT CHANGE | INPUT CHANGE | 10h | 86h | 0: No mean 1: NORMAL 2: QUICK 3: SUPER | When you set up "SUPER", please set up INPUT1 and INPUT2 first. |
| | | INPUT1 | 10h | CEh | 0: No mean 3: DVI1 4: DVI2 13(0Dh): OPTION 15(0Fh): DPORT 16(10h): DPORT2 17(11h): HDMI1 18(12h): HDMI2 130(82h): HDMI3 131(83h): HDMI4 132(84h): PRESET1 133(85h): PRESET2 134(86h): PRESET3 | |
| INPUT2 | | 10h | CFh | | | |
| TERMINAL SETTING | HDMI/DVI SELECT | 11h | 18h | 0: No mean 1: HDMI 2: DVI 3: HDMI/DVI | | |
| | INPUT CONFIGURATION | Refer to section 6.4 | | | | |

| Item | | OP code page | OP code | Parameter | Remarks | |
|--------------------------|-------------------|--------------|---------|--|-------------------------------|--|
| | DVI MODE | 02h | CFh | 0: No mean 1: DVI-PC 2: DVI-HD | | |
| | DisplayPort | 10h | F1h/F2h | Select target DPORT. (F1h) 0: No mean 1: DPORT 2: DPORT2 Read / Write status of target DPORT. (F2h) 0: No mean 1: 1.1a 2: 1.2 | | |
| | BIT RATE | 11h | 19h | 0: No mean 1: RBR 2: HBR 3: HBR2 | | |
| | HDMI SIGNAL | 10h | 40h | 0: No mean 1: EXPAND 2: RAW | | |
| DEINTERLACE | | 02h | 25h | 0: No mean 1: Off 2: ON | | |
| MOVIE SETTING | TELECINE | 02h | 23h | 0: No mean 1: OFF 2: AUTO | | |
| | ADAPTIVE CONTRAST | 02h | 8Dh | 0: No mean 1: OFF 2: LOW 4: HIGH | | |
| OVER SCAN | | 02h | E3h | 0: No mean 1: OFF 2: ON | | |
| OPTION SETTING | OPTION POWER | 10h | 41h | 0: OFF 1: ON | | |
| | AUDIO | 10h | B0h | 0: No mean 1: ANALOG 2: DIGITAL | | |
| | INTERNAL PC | OFF WARNING | 10h | C0h | 0: No mean 1: OFF 2: ON | |
| | | AUTO OFF | 10h | C1h | 0: No mean 1: OFF 2: ON | |
| | | START UP PC | 10h | C2h | 0: No mean 1: Execute | |
| FORCE QUIT | | 10h | C3h | 0: No mean 1: Execute | | |
| 120Hz | | 10h | 87h | 0: No mean 1: ON 2: OFF | | |
| TOUCH PANEL | STANDBY | 10h | C4h | 0: No mean 1: OFF 2: ON | | |
| | PC SOURCE | 10h | C5h | 0: No mean 1: AUTO 2: EXTERNAL PC | | |
| RESET (ADVANCED OPTION1) | | 02h | CBh | 0: No mean 10(0Ah): Reset Advanced option1 category | Momentary | |

| Item | | OP code page | OP code | Parameter | Remarks | |
|--------------------------|--------------------|--------------|---------|---|---|-----------|
| AUTO DIMMING | AUTO BRIGHTNESS | 02h | 2Dh | 0: OFF 1: ON | | |
| | BACKLIGHT DIMMING | 11h | 4Eh | 0: No mean 1: OFF 2: ON | | |
| | ROOM LIGHT SENSING | 10h | C8h | 0: No mean 1: OFF 2: MODE1 3: MODE2 | | |
| | BACK LIGHT SETTING | MAX LIMIT | 10h | C9h | 0 - 100 (64h) | |
| | | IN BRIGHT | 10h | 33h | 0 - 100 (64h) | |
| | | IN DARK | 10h | 34h | 0 - 100 (64h) | |
| | | SENSING LUX | 02h | B4h | Current luminance read | Read only |
| HUMAN SENSING | HUMAN SENSING MODE | 10h | 75h | 0: No mean 1: DISABLE 2: AUTO OFF 4: CUSTOM | | |
| | BACK LIGHT | ON/OFF | 10h | DDh | 0: No mean 1: Off 2: On | |
| | | BACK LIGHT | 10h | C6h | 0: dark 100 (64h): light | |
| | VOLUME | ON/OFF | 10h | DEh | 0: No mean 1: Off 2: On | |
| | | VOLUME | 10h | C7h | 0: whisper 100 (64h): loud | |
| | INPUT SELECT | ON/OFF | 10h | DFh/D0h | 0: No mean 1: Off 2: On | |
| | | INPUT | 10h | D0h | 0: No mean 3: DVI1 4: DVI2 13 (0Dh): OPTION 15 (0Fh): DPORT 16 (10h): DPORT2 17 (11h): HDMI1 18 (12h): HDMI2 130 (82h): HDMI3 131 (83h): HDMI4 132 (84h): PRESET1 133 (85h): PRESET2 134 (86h): PRESET3 | |
| WAITING TIME | | 10h | 78h | 30 (1Eh): short 600 (258h): long *1step: 1sec. | | |
| INTELLI WIRELESS DATA | | 10h | ECh | 0: No mean 1: OFF 2: ON | | |
| RESET (ADVANCED OPTION2) | | 02h | CBh | 0: No mean 11 (0Bh): Reset Advanced option category | Momentary | |
| FACTORY RESET | | 02h | CBh | 0: No mean 1: Factory Reset | Momentary | |

ADVANCED OPTION2

| Item | OP code page | OP code | Parameter | Remarks |
|---|--------------|---------|---|---|
| INPUT | 11h | 06h | 0: No mean 3: DVI1 4: DVI2 13(0Dh): OPTION 15(0Fh): DPORT 16(10h): DPORT2 17(11h): HDMI1 18(12h): HDMI2 130(82h): HDMI3 131(83h): HDMI4 132(84h): PRESET1 133(85h): PRESET2 134(86h): PRESET3 | The following commands can also be used. OP code page 00h OP code 60h Parameter 0: No mean 3: DVI1 4: DVI2 13: OPTION 15: DPORT 16: DPORT2 17: HDMI1 18: HDMI2 |
| AUDIO INPUT | 02h | 2Eh | 0: No mean 1: LINE IN 4: HDMI 6: OPTION 7: DPORT 8: DPORT2 10(0Ah): HDMI2 11(0Bh): HDMI3 12(0Ch): HDMI4 | |
| VOLUME UP/DOWN | 00h | 62h | 0: whisper 100(64h): loud | |
| MUTE | 00h | 8Dh | 0: UNMUTE(Set only) 1: MUTE 2: UNMUTE | |
| SCREEN MUTE | 10h | B6h | 0: No mean 1: SCREEN MUTE ON 2: SCREEN MUTE OFF | |
| MTS | 02h | 2Ch | 0: No mean 1: Main 2: Sub 3: Main + Sub | This operation requires supported option TV tuner. |
| PICTURE MODE | 02h | 1Ah | 0: No mean 1: sRGB 3: HIGHBRIGHT 4: STANDARD 5: CINEMA 8: CUSTOM1 9: CUSTOM2 13(0Dh): SVE-1 SETTING 14(0Eh): SVE-2 SETTING 15(0Fh): SVE-3 SETTING 16(10h): SVE-4 SETTING 17(11h): SVE-5 SETTING | sRGB: PC mode only CINEMA: A/V mode only |
| ASPECT | 02h | 70h | 0: No mean 1: NORMAL 2: FULL 3: WIDE 4: ZOOM 6: DYNAMIC 7: 1:1 (Off/dot by dot) | WIDE: A/V mode only |
| MULTI PICTURE MODE ON/OFF STILL ON/OFF | 02h | 72h | 0: No mean 1: Off 2: PIP 4: STILL 5: PBP(PBP1, PBP2, PBP3) | |

| | Item | OP code page | OP code | Parameter | Remarks |
|--------------------|-------------------------------|--------------|---------|---|--|
| | PICTURE NUMBER | 10h | B5h | If MULTI PICTURE is set PIP 0: No mean 2: 2WINDOWS, PIP 3: 3WINDOWS, PIP If MULTI PICTURE is set PBP 0: No mean 1: 2WINDOWS, PBP1 3: 3WINDOWS, PBP1 4: 3WINDOWS, PBP2 5: 3WINDOWS, PBP3 6: 4WINODWS, PBP1 | |
| | MULTI PICTURE INPUT | 02h | 73h | 0: No mean 3: DVI1 4: DVI2 13(0Dh): OPTION 15(0Fh): DPORT 16(10h): DPORT2 17(11h): HDMI1 18(12h): HDMI2 130(82h): HDMI3 131(83h): HDMI4 | |
| | ACTIVE PICTURE | 11h | 0Bh | 0: No mean 1: PICTURE1 2: PICTURE2 3: PICTURE3 4: PICTURE4 | |
| | ROTATE | | | | |
| | | ROTATE ALL | 11h | 16h | 0: No mean |
| | | PICTURE1 | 11h | 12h | 1: OFF |
| | | PICTURE2 | 11h | 13h | 2: ON |
| | | PICTURE3 | 11h | 14h | |
| | | PICTURE4 | 11h | 15h | |
| | STILL CAPTURE | 02h | 76h | 0: OFF 1: CAPTURE | Momentary |
| | SIGNAL INFORMATION | 02h | EAh | 0: No mean 1: OFF 2: ON | |
| | TV-CHANNEL UP/DOWN | 00h | 8Bh | 0: No mean 1: UP 2: DOWN | This operation requires supported option TV tuner. |
| TEMPERATURE SENSOR | SELECT TEMPERATURE SENSOR | 02h | 78h | 0: No mean 1: SENSOR #1 2: SENSOR #2 3: SENSOR #3 | |
| | READOUT A TEMPERATURE | 02h | 79h | Returned value is 2's complement. Refer to section 6.2 | Read only |
| CARBON FOOTPRINT | READOUT CARBON FOOTPRINT (g) | 10h | 10h | 0: 999(3E7h): | Read only |
| | READOUT CARBON FOOTPRINT (kg) | 10h | 11h | 0: 65535(FFFFh): | Read only |
| | READOUT CARBON USAGE (g) | 10h | 26h | 0: 999(3E7h): | Read only |

| | Item | OP code page | OP code | Parameter | Remarks |
|--|---------------------------|--------------|---------|----------------------------|-----------|
| | READOUT CARBON USAGE (kg) | 10h | 27h | 0: 65535 (FFFFh) : | Read only |

6.4. Operation Code (OP code) for INPUT CONFIGURATION

| Item | OP code page | OP code | Parameter | Remarks | |
|--------------|--------------|---------|--|--|--|
| PRESET1 | 11h | 1Fh | 0: No mean 1: OFF 2: LEFT & RIGHT (HDMIx2 or DVIx2) 3: TOP & BOTTOM (HDMIx2 or DVIx2) 4: DIVIDE QUARTERS (HDMI x 4) | | |
| PRESET2 | 11h | 20h | 0: No mean 1: OFF 2: LEFT & RIGHT (HDMIx2 or DVIx2) 3: TOP & BOTTOM (HDMIx2 or DVIx2) | | |
| PRESET3 | 11h | 21h | 0: No mean 1: OFF 2: LEFT & RIGHT (DPORTx2) 3: TOP & BOTTOM (DPORTx2) | | |
| SELECT INPUT | TOP LEFT | 11h | 22h | 0: No mean 3: DVI1 4: DVI2 13(0Dh): OPTION 15(0Fh): DPORT 16(10h): DPORT2 17(11h): HDMI1 18(12h): HDMI2 130(82h): HDMI3 131(83h): HDMI4 | Set up, when PRESET1 is set as "DIVIDE QUARTERS". |
| | TOP RIGHT | 11h | 23h | | |
| | BOTTOM LEFT | 11h | 24h | | |
| | BOTTOM RIGHT | 11h | 25h | | |
| | LEFT | 11h | 26h | | Set up, when PRESET1, 2 or 3 is set as "LEFT & RIGHT" or "TOP & BOTTOM". |
| | RIGHT | 11h | 27h | | |
| | TOP | 11h | 28h | | |
| | BOTTOM | 11h | 29h | | |

7. Power control procedure

7.1 Power status read

- 1) The controller requests the monitor to reply a current power status.

| Header | Message | Check code | Delimiter |
|------------------------------------|-------------------------|------------|-----------|
| SOH-'0'-Monitor ID-'0'-'A'-'0'-'6' | STX-'0'-'1'-'D'-'6'-ETX | BCC | CR |

Header

SOH (01h): Start of Header
 '0' (30h): Reserved
 Monitor ID: Specify the Monitor ID from which you want to get status.
 Ex.) If Monitor ID is '1', specify 'A'.
 '0' (30h): Message sender is the controller.
 'A' (41h): Message Type is "Command".
 '0'-'6' (30h, 36h): Message length is 6 bytes.

Message

STX (02h): Start of Message
 '0'-'1'-'D'-'6': Get power status command.
 ETX (03h): End of Message

Check code

BCC: Block Check Code
 Refer to the section 4.3 "Check code" for a BCC calculation.

Delimiter

CR (0Dh): End of packet

- 2) The monitor returns with the current power status.

| Header | Message | Check code | Delimiter |
|------------------------------------|---|------------|-----------|
| SOH-'0'-'0'-Monitor ID-'B'-'1'-'2' | STX-'0'-'2'-'0'-'0'-'D'-'6'-'0'-'0'-'0'-'0'-'4'-'0'-'0'-'0'-'1'-ETX | BCC | CR |

Header

SOH (01h): Start of Header
 '0' (30h): Reserved
 '0' (30h): Message receiver is the controller.
 Monitor ID: Indicate a replying Monitor ID.
 Ex.) When this byte is set to 'A', the replying Monitor ID is '1'.
 'B' (42h): Message Type is "Command reply".
 '1'-'2' (31h, 32h): Message length is 18 bytes.

Message

STX (02h): Start of Message
 '0'-'2' (30h, 32h): Reserved data
 '0'-'0' (30h, 30h): Result code
 00: No Error.
 01: Unsupported.
 'D'-'6' (44h, 36h): Display power mode code
 '0'-'0' (30h, 30h): Parameter type code is "Set parameter".
 '0'-'0'-'0'-'4' (30h, 30h, 30h, 34h): Power mode is 4 types.
 '0'-'0'-'0'-'1' (30h, 30h, 30h, 31h): Current power mode
 <Status>
 0001: ON
 0002: Stand-by (power save)
 0003: Suspend (power save)
 0004: OFF (same as IR power off)
 ETX (03h): End of Message

Check code

BCC: Block Check Code

Refer to the section 4.3 "Check code" for a BCC calculation.

Delimiter

CR (0Dh): End of packet

7.2 Power control

1) The controller requests the monitor to control monitor power.

| Header | Message | Check code | Delimiter |
|------------------------------------|---|------------|-----------|
| SOH-'0'-Monitor ID-'0'-'A'-'0'-'C' | STX-'C'-'2'-'0'-'3'-'D'-'6'-'0'-'0'-'0'-'1'-ETX | BCC | CR |

Header

SOH (01h): Start of Header
 '0' (30h): Reserved
 Monitor ID: Specify the Monitor ID which you want to change a setting.
 Ex.) If Monitor ID is '1', specify 'A'.
 '0' (30h): Message sender is the controller.
 'A' (41h): Message type is "Command".
 '0'-'C' (30h, 43h): Message length is 12 bytes.

Message

STX (02h): Start of Message
 'C'-'2'-'0'-'3'-'D'-'6' (43h, 32h, 30h, 33h, 44h, 36h): power control command
 '0'-'0'-'0'-'1' (30h, 30h, 30h, 31h): Power mode
 0001: ON
 0002, 0003: Do not set.
 0004: OFF (same as the power off by IR)

ETX (03h): End of Message

Check code

BCC: Block Check Code
 Refer to the section 4.3 "Check code" for a BCC calculation.

Delimiter

CR (0Dh): End of packet

2) The monitor replies a data for confirmation.

| Header | Message | Check code | Delimiter |
|------------------------------------|---|------------|-----------|
| SOH-'0'-'0'-Monitor ID-'B'-'0'-'E' | STX-'0'-'0'-'C'-'2'-'0'-'3'-'D'-'6'-'0'-'0'-'0'-'1'-ETX | BCC | CR |

Header

SOH (01h): Start of Header
 '0' (30h): Reserved
 '0' (30h): Message receiver is the controller.
 Monitor ID: Indicate a replying Monitor ID.
 Ex.) When this byte is set to 'A', the replying Monitor ID is '1'.
 'B' (42h): Message type is "Command reply".
 'N'-'N': Message length
 Note.) The maximum data length that can be written to the monitor at a time is 32bytes.
 Ex.) The byte data 20h is encoded as ASCII characters '2' and '0' (32h and 30h).

Message

STX (02h): Start of Message
 '0'-'0' (30h, 30h): Result code. No error.
 'C'-'2', '0'-'3'-'D'-'6' (43h, 32h, 30h, 33h, 44h, 36h): power control reply command
 ➤ The monitor replies same as power control command to the controller.
 '0'-'0'-'0'-'1' (30h, 30h, 30h, 31h): Power mode
 0001: ON
 0002, 0003: Do not set.
 0004: OFF (same as the power off by IR)

ETX (03h): End of Message

Check code

BCC: Block Check Code

Refer to the section 4.3 "Check code" for a BCC calculation.

Delimiter

CR (0Dh): End of packet

8. Asset Data read and write

MultiSync X841UHD, X981UHD, X651UHD have the area for to store user's asset data of up to 64bytes.

8.1 Asset Data Read Request and reply

This command is used in order to read Asset Data.

1) The controller requests the monitor to reply with Asset data.

| Header | Message | Check code | Delimiter |
|------------------------------------|---|------------|-----------|
| SOH-'0'-Monitor ID-'0'-'A'-'0'-'A' | STX-'C'-'0'-'0'-'B'-'0'-'0'-'2'-'0'-ETX | BCC | CR |

Header

SOH (01h): Start of Header

'0' (30h): Reserved

Monitor ID: Specify the Monitor ID from which you want to get data.

Ex.) If Monitor ID is '1', specify 'A'.

'0' (30h): Message sender is the controller.

'A' (41h): Message type is "Command".

'0'-'A' (30h, 41h): Message length is 10 bytes.

Message

STX (02h): Start of Message

'C'-'0'-'0'-'B' (43h, 30h, 30h, 42h): Asset read request command.

'0'-'0' (30h, 30h): Offset data from top of the Asset data.

At first set 00h: Read data from the top of Asset data area.

'2'-'0' (32h, 30h): Read out data length is 32bytes.

Secondly set 20h: Read data from the 32bytes offset point in the Asset data area.

Maximum readout length is 32bytes at a time.

ETX (03h): End of Message

Check code

BCC: Block Check Code

Refer to the section 4.3 "Check code" for a BCC calculation.

Delimiter

CR (0Dh): End of packet

2) The monitor replies Asset data to the controller.

| Header | Message | Check code | Delimiter |
|-----------------------------|--|------------|-----------|
| SOH-'0'-'0'-'0'-'B'-'N'-'N' | STX-'C'-'1'-'0'-'B'-'Data(0)-Data(1)---Data(N)-ETX | BCC | CR |

Header

SOH (01h): Start of Header

'0' (30h): Reserved

'0' (30h): Message receiver is the controller.

Monitor ID: Indicate a replying Monitor ID.

Ex.) When this byte is set to 'A', the replying Monitor ID is '1'.

'B' (42h): Message type is "Command reply"

N-N: Message length

Note.) This length includes STX and ETX.

Message

STX (02h): Start of Message

'C'-'1'-'0'-'B' (43h, 31h, 30h, 42h): Asset read reply command

Data(0) - Data(N): Retuned Asset data

Ex.) When Data(n) is 1234h, replying data is (31h 32h, 33h, 34h).

ETX (03h): End of Message

Check code

BCC: Block Check Code

Refer to the section 4.3 "Check code" for a BCC calculation.

Delimiter

CR (0Dh): End of packet

8.2 Asset Data write

This command is used in order to write Asset Data.

1) The controller requests the monitor to write Asset data.

| Header | Message | Check code | Delimiter |
|--------------------------------|---|------------|-----------|
| SOH-'0'-Monitor ID-'0'-'A'-N-N | STX-'C'-'0'-'0'-'E'-'0'-'0'-Data(0)-Data(1)---Data(N)-ETX | BCC | CR |

Header

SOH (01h): Start of Header

'0' (30h): Reserved

Monitor ID: Specify the Monitor ID in which you want to write data.

Ex.) If Monitor ID is '1', specify 'A'.

'0' (30h): Message sender is the controller.

'A' (41h): Message type is "Command".

N-N: Message length

Note.) The maximum data length that can be written to the monitor at a time is 32bytes.

Message

STX (02h): Start of Message

'C'-'0'-'0'-'E' (43h, 30h, 30h, 45h): Asset Data writes command

'0'-'0'(30h, 30h): Offset address from top of Asset data.

00h : Write data from top of the Asset data area.

Data(0) -- Data(N): Asset data. The data must be ASCII characters strings.

ETX (03h): End of Message

Check code

BCC: Block Check Code

Refer to the section 4.3 "Check code" for a BCC calculation.

Delimiter

CR (0Dh): End of packet

2) The monitor replies a data for confirmation.

| Header | Message | Check code | Delimiter |
|--------------------------------|---|------------|-----------|
| SOH-'0'-'0'-Monitor ID-'B'-N-N | STX-'0'-'0'-'C'-'0'-'0'-'E'-'0'-'0'-Data(0)-Data(1)---Data(N)-ETX | BCC | CR |

Header

SOH (01h): Start of Header

'0' (30h): Reserved

'0' (30h): Message receiver is the controller.

Monitor ID: Indicate a replying Monitor ID.

Ex.) When this byte is set to 'A', the replying Monitor ID is '1'.

'B' (42h): Message type is "Command reply".

N-N: Message length

Note.) The maximum data length that can be written to the monitor at a time is 32bytes.

Message

STX (02h): Start of Message

'0'-'0': Result code. No error.

'C'-'0'-'0'-'E' (43h, 30h, 30h, 45h): Asset Data write command

'0'-'0'(30h, 30h): Offset address from top of Asset data.

00h : Write data into from top of the Asset data area.

Data(0) -- Data(N): Asset data. The data must be ASCII characters strings.

ETX (03h): End of Message

Check code

BCC: Block Check Code

Refer to the section 4.3 "Check code" for a BCC calculation.

Delimiter

CR (0Dh): End of packet

9. Date & Time read and write

9.1 Date & Time Read

This command is used in order to read the setting of Date & Time.

- 1) The controller requests the monitor to reply with the Date & Time.

| Header | Message | Check code | Delimiter |
|------------------------------------|-------------------------|------------|-----------|
| SOH-'0'-Monitor ID-'0'-'A'-'0'-'6' | STX-'C'-'2'-'1'-'1'-ETX | BCC | CR |

Header

SOH (01h): Start of Header

'0' (30h): Reserved

Monitor ID: Specify the Monitor ID of which you want to get status.

Ex.) If Monitor ID is '1', specify 'A'.

'0' (30h): Message sender is the controller.

'A' (41h): Message type is "Command".

'0'-'6' (30h, 36h): Message length

Message

STX (02h): Start of Message

'C'-'2'-'1'-'1' (43h, 32h, 31h, 31h): Date & time read request command.

ETX (03h): End of Message

Check code

BCC: Block Check Code

Refer to the section 4.3 "Check code" for a BCC calculation.

Delimiter

CR (0Dh): End of packet

- 2) The monitor replies Date & Time to the controller.

| Header | Message | Check code | Delimiter |
|------------------------------------|--|------------|-----------|
| SOH-'0'-'0'-Monitor ID-'B'-'1'-'4' | STX-'C'-'3'-'1'-'1'-YY-MM-DD-WW-HH-MN-DS-ETX | BCC | CR |

Header

SOH (01h): Start of Header

'0' (30h): Reserved

'0' (30h): Message receiver is the controller

Monitor ID: Indicate a replying Monitor ID

Ex.) When this byte is set to 'A', the replying Monitor ID is '1'.

'B' (42h): Message type is "Command reply"

'1'-'4' (31h, 34h): Message length

Message

STX (02h): Start of Message

'C'-'3'-'1'-'1' (43h, 33h, 31h, 31h): Date & Time read reply command

'YY'-'MM'-'DD'-'WW'-'HH'-'MN'-'DS': Date & Time data

YY: Year (offset 2000)

'0'-'0' (30h, 30h): 2000

|

'6'-'3' (36h, 33h): 2099 (99 = 63h)

MM: Month

'0'-'1' (30h, 31h): January

|

'0'-'C' (30h, 43h): December

DD: Day

'0'-'1' (30h, 31h): 1

|

'1'-'E' (31h, 45h): 30 (=1Eh)

'1'-'F' (31h, 46h): 31 (=1Fh)

WW: weekdays

'0'-'0' (30h, 30h): Sunday
'0'-'1' (30h, 31h): Monday
'0'-'2' (30h, 32h): Tuesday
'0'-'3' (30h, 33h): Wednesday
'0'-'4' (30h, 34h): Thursday
'0'-'5' (30h, 35h): Friday
'0'-'6' (30h, 36h): Saturday

HH: Hours

'0'-'0' (30h, 30h): 0
|
'1'-'7' (31h, 37h): 23 (=17h)

MN: Minutes

'0'-'0' (30h, 30h): 0
|
'3'-'B' (33h, 42h): 59 (=3Bh)

DS: Daylight saving (Summer time)

'0'-'0' (30h, 30h): NO
'0'-'1' (30h, 31h): YES

ETX (03h): End of Message

Check code

BCC: Block Check Code

Refer to the section 4.3 "Check code" for a BCC calculation.

Delimiter

CR (0Dh): End of packet

9.2 Date & Time Write

This command is used in order to write the setting of the Date & Time.

- 1) The controller requests the monitor to write Date & Time.

| Header | Message | Check code | Delimiter |
|------------------------------------|---|------------|-----------|
| SOH-'0'-Monitor ID-'0'-'A'-'1'-'2' | STX-'C'-'2'-'1'-'2'-'YY-MM-DD-WW-HH-MN-DS-ETX | BCC | CR |

Header

SOH (01h): Start of Header
 '0' (30h): Reserved
 Monitor ID: Specify the Monitor ID of which you want to change the setting.
 Ex.) If Monitor ID is '1', specify 'A'.
 '0' (30h): Message sender is the controller.
 'A' (41h): Message type is "Command".
 '1'-'2' (31h, 32h): Message length

Message

STX (02h): Start of Message
 'C'-'2'-'1'-'2' (43h, 32h, 31h, 32h): Date & Time write command
 'YY'-'MM'-'DD'-'WW'-'HH'-'MN'-'DS': Date & Time data
 YY: Year (offset 2000)
 '0'-'0' (30h, 30h): 2000
 |
 '6'-'3' (36h, 33h): 2099 (99 = 63h)

 MM: Month
 '0'-'1' (30h, 31h): JANUARY
 |
 '0'-'C' (30h, 43h): DECEMBER

 DD: Day
 '0'-'1' (30h, 31h): 1
 |
 '1'-'E' (31h, 45h): 30 (=1Eh)
 '1'-'F' (31h, 46h): 31 (=1Fh)

 WW: weekdays
 '0'-'0' (30h, 30h): SUNDAY
 '0'-'1' (30h, 31h): MONDAY
 '0'-'2' (30h, 32h): TUESDAY
 '0'-'3' (30h, 33h): WEDNESDAY
 '0'-'4' (30h, 34h): THURSDAY
 '0'-'5' (30h, 35h): FRIDAY
 '0'-'6' (30h, 36h): SATURDAY

 HH: Hours
 '0'-'0' (30h, 30h): 0
 |
 '1'-'7' (31h, 37h): 23 (=17h)

 MN: Minutes
 '0'-'0' (30h, 30h): 0
 |
 '3'-'B' (33h, 42h): 59 (=3Bh)

 DS: Daylight saving (Summer time)
 '0'-'0' (30h, 30h): NO
 '0'-'1' (30h, 31h): YES

ETX (03h): End of Message

Check code

BCC: Block Check Code
 Refer to the section 4.3 "Check code" for a BCC calculation.

Delimiter

CR (0Dh): End of packet

2) The monitor replies a data for confirmation.

| Header | Message | Check code | Delimiter |
|------------------------------------|---|------------|-----------|
| SOH-'0'-'0'-Monitor ID-'B'-'1'-'6' | STX-'C'-'3'-'1'-'2'-ST-YY-MM-DD-WW-HH-MN-DS-ETX | BCC | CR |

Header

SOH (01h): Start of Header

'0' (30h): Reserved

'0' (30h): Message receiver is the controller.

Monitor ID: Indicate a replying Monitor ID.

Ex.) When this byte is set to 'A', the replying Monitor ID is '1'.

'B' (42h): Message type is "Command reply".

'1'-'6' (31h, 36h): Message length

Message

STX (02h): Start of Message

'C'-'3'-'1'-'2' (43h, 33h, 31h, 32h): Date & Time write reply command

ST: Date & Time Status command

'0'-'0' (30h, 30h): No error

'0'-'1' (30h, 31h): Error

'YY'-'MM'-'DD'-'WW'-'HH'-'MN'-'DS': Date & Time data

YY: Year (offset 2000)

'0'-'0' (30h, 30h): 2000

|

'6'-'3' (36h, 33h): 2099 (99 = 63h)

MM: Month

'0'-'1' (30h, 31h): JANUARY

|

'0'-'C' (30h, 43h): DECEMBER

DD: Day

'0'-'1' (30h, 31h): 1

|

'1'-'E' (31h, 45h): 30 (=1Eh)

'1'-'F' (31h, 46h): 31 (=1Fh)

WW: weekdays

'0'-'0' (30h, 30h): SUNDAY

'0'-'1' (30h, 31h): MONDAY

'0'-'2' (30h, 32h): TUESDAY

'0'-'3' (30h, 33h): WEDNESDAY

'0'-'4' (30h, 34h): THURSDAY

'0'-'5' (30h, 35h): FRIDAY

'0'-'6' (30h, 36h): SATURDAY

HH: Hours

'0'-'0' (30h, 30h): 0

|

'1'-'7' (31h, 37h): 23 (=17h)

MN: Minutes

'0'-'0' (30h, 30h): 0

|

'3'-'B' (33h, 42h): 59 (=3Bh)

DS: Daylight saving (Summer time)

'0'-'0' (30h, 30h): NO

'0'-'1' (30h, 31h): YES

ETX (03h): End of Message

Check code

BCC: Block Check Code

Refer to the section 4.3 "Check code" for a BCC calculation.

Delimiter

CR (0Dh): End of packet

10. Schedule read and write

10.1 Schedule Read

This command is used in order to read the setting of the Schedule.

- 1) The controller requests the monitor to read Schedule.

| Header | Message | Check code | Delimiter |
|------------------------------------|----------------------------|------------|-----------|
| SOH-'0'-Monitor ID-'0'-'A'-'0'-'8' | STX-'C'-'2'-'2'-'1'-PG-ETX | BCC | CR |

Header

SOH (01h): Start of Header
 '0' (30h): Reserved
 Monitor ID: Specify the Monitor ID of which you want to get status.
 Ex.) If Monitor ID is '1', specify 'A'.
 '0' (30h): Message sender is the controller.
 'A' (41h): Message type is "Command".
 '0'-'8' (30h, 38h): Message length

Message

STX (02h): Start of Message
 'C'-'2'-'2'-'1' (43h, 32h, 32h, 31h): Schedule read request command.
 PG: Program No.
 ➤ The data must be ASCII characters strings.
 ETX (03h): End of Message

Check code

BCC: Block Check Code
 Refer to the section 4.3 "Check code" for a BCC calculation.

Delimiter

CR (0Dh): End of packet

- 2) The monitor replies Schedule to the controller.

| Header | Message | Check code | Delimiter |
|------------------------------------|--|------------|-----------|
| SOH-'0'-'0'-Monitor ID-'B'-'2'-'6' | STX-'C'-'3'-'2'-'1'-PG-ON HOUR-ON MIN-OFF HOUR-OFF MIN-INPUT-WD-FL-P MODE-EXT1-EXT2-EXT3-EXT4-EXT5-EXT6-EXT7-ETX | BCC | CR |

Header

SOH (01h): Start of Header
 '0' (30h): Reserved
 '0' (30h): Message receiver is the controller.
 Monitor ID: Indicate a replying Monitor ID.
 Ex.) When this byte is set to 'A', the replying Monitor ID is '1'.
 'B' (42h): Message type is "Command reply".
 '2'-'6' (32h, 36h): Message length

Message

STX (02h): Start of Message
 'C'-'3'-'2'-'1' (43h, 33h, 32h, 31h): Schedule read reply command
 PG-ON HOURS-ON MIN-OFF HOURS-OFF MIN-INPUT-WD-FL-P MODE-EXT1-EXT2-EXT3-EXT4-EXT5-EXT6-EXT7: Schedule data
 PG: Program No.
 '0'-'0' (30h, 30h): Program No.1
 |
 '0'-'6' (30h, 36h): Program No.7

 ON_HOUR: Turn on time (hour)
 '0'-'0' (30h, 30h): 00
 |
 '1'-'7' (31h, 37h): 23 (=17h)
 '1'-'8' (31h, 38h): ON timer isn't set.

```

ON_MIN: Turn on time (minute)
'0'-'0' (30h, 30h): 0
|
'3'-'B' (33h, 42h): 59
'3'-'C' (33h, 43h): On timer isn't set.

OFF_HOUR: Turn off time (hour)
'0'-'0' (30h, 30h): 00
|
'1'-'7' (31h, 37h): 23 (=17h)
'1'-'8' (31h, 38h): Off timer isn't set.

OFF_MIN: Turn off time (minute)
'0'-'0' (30h, 30h): 0
|
'3'-'B' (33h, 42h): 59 (=3Bh)
'3'-'C' (33h, 43h): Off timer isn't set.

INPUT: Timer input
'0'-'0' (30h,30h): No mean (works on last memory)
'0'-'3' (30h,33h): DVI1
'0'-'4' (30h,34h): DVI2
'0'-'D' (30h,44h): OPTION
'0'-'F' (30h,46h): DPORT
'1'-'0' (31h,30h): DPORT2
'1'-'1' (31h,31h): HDMI
'1'-'2' (31h,32h): HDMI2
'8'-'2' (38h,32h): HDMI3
'8'-'3' (38h,33h): HDMI4

WD: Week setting
bit 0: MONDAY
bit 1: TUESDAY
bit 2: WEDNESDAY
bit 3: THURSDAY
bit 4: FRIDAY
bit 5: SATURDAY
bit 6: SUNDAY

EX.
'0'-'1' (30h, 31h): MONDAY
'0'-'4' (30h, 34h): TUESDAY
'0'-'F' (30h, 46h): MONDAY, TUESDAY, WEDNESDAY and THURSDAY
'7'-'F' (37h, 46h): MONDAY to SUNDAY

FL: Option
bit 0: 0:once 1:Everyday
bit 1: 0:once 1:Every week
bit 2: 0:Disable 1:Enable

EX.
'0'-'1' (30h, 31h): Disable, Everyday
'0'-'4' (30h, 34h): Enable, once

P MODE: Picture mode
'0'-'0' (30h,30h): No mean (works on last memory)
'0'-'1' (30h,31h): sRGB
'0'-'3' (30h,33h): HIGHBRIGHT
'0'-'4' (30h,34h): STANDARD
'0'-'5' (30h,34h): CINEMA
'0'-'8' (30h,38h): CUSTOM1
'0'-'9' (30h,39h): CUSTOM2
'0'-'D' (30h,44h): SVE-1 SETTING
'0'-'E' (30h,45h): SVE-2 SETTING
'0'-'F' (30h,46h): SVE-3 SETTING
'1'-'0' (31h,30h): SVE-4 SETTING
'1'-'1' (31h,31h): SVE-5 SETTING

```

EXT1: Extension 1
 '0'-'0' (30h,30h): (On this monitor, it is always '00')

EXT2: Extension 2
 '0'-'0' (30h,30h): (On this monitor, it is always '00')

EXT3: Extension 3
 '0'-'0' (30h,30h): (On this monitor, it is always '00')

EXT4: Extension 4
 '0'-'0' (30h,30h): (On this monitor, it is always '00')

EXT5: Extension 5
 '0'-'0' (30h,30h): (On this monitor, it is always '00')

EXT6: Extension 6
 '0'-'0' (30h,30h): (On this monitor, it is always '00')

EXT7: Extension 7
 '0'-'0' (30h,30h): (On this monitor, it is always '00')

ETX (03h): End of Message

Check code

BCC: Block Check Code

Refer to the section 4.3 "Check code" for a BCC calculation.

Delimiter

CR (0Dh): End of packet

*****Following command also can be used for to keep backward compatibility, in order to read the setting of the Schedule.**

1) The controller requests the monitor to read Schedule.

| Header | Message | Check code | Delimiter |
|------------------------------------|----------------------------|------------|-----------|
| SOH-'0'-Monitor ID-'0'-'A'-'0'-'8' | STX-'C'-'2'-'1'-'3'-PG-ETX | BCC | CR |

Header

SOH (01h): Start of Header
 '0' (30h): Reserved
 Monitor ID: Specify the Monitor ID of which you want to get status.
 Ex.) If Monitor ID is '1', specify 'A'.
 '0' (30h): Message sender is the controller.
 'A' (41h): Message type is "Command".
 '0'-'8' (30h, 38h): Message length

Message

STX (02h): Start of Message
 'C'-'2'-'1'-'3' (43h, 32h, 31h, 33h): Schedule read request command.
 PG: Program No.
 ➤ The data must be ASCII characters strings.
 ETX (03h): End of Message

Check code

BCC: Block Check Code
 Refer to the section 4.3 "Check code" for a BCC calculation.

Delimiter

CR (0Dh): End of packet

2) The monitor replies Schedule to the controller.

| Header | Message | Check code | Delimiter |
|------------------------------------|--|------------|-----------|
| SOH-'0'-'0'-Monitor ID-'B'-'1'-'6' | STX-'C'-'3'-'1'-'3'-PG-ON HOUR-ON MIN-OFF HOUR-OFF MIN-INPUT-WD-FL-ETX | BCC | CR |

Header

SOH (01h): Start of Header
 '0' (30h): Reserved
 '0' (30h): Message receiver is the controller.
 Monitor ID: Indicate a replying Monitor ID.
 Ex.) When this byte is set to 'A', the replying Monitor ID is '1'.
 'B' (42h): Message type is "Command reply".
 '1'-'6' (31h, 36h): Message length

Message

STX (02h): Start of Message
 'C'-'3'-'1'-'3' (43h, 33h, 31h, 33h): Schedule read reply command
 PG-ON HOURS-ON MIN-OFF HOURS-OFF MIN-INPUT-WD-FL: Schedule data
 PG: Program No.
 '0'-'0' (30h, 30h): Program No.1
 |
 '0'-'6' (30h, 36h): Program No.7

 ON_HOUR: Turn on time (hour)
 '0'-'0' (30h, 30h): 00
 |
 '1'-'7' (31h, 37h): 23 (=17h)
 '1'-'8' (31h, 38h): ON timer isn't set.

ON_MIN: Turn on time (minute)
 '0'-'0' (30h, 30h): 0
 |
 '3'-'B' (33h, 42h): 59
 '3'-'C' (33h, 43h): On timer isn't set.

OFF_HOUR: Turn off time (hour)
 '0'-'0' (30h, 30h): 00
 |
 '1'-'7' (31h, 37h): 23 (=17h)
 '1'-'8' (31h, 38h): Off timer isn't set.

OFF_MIN: Turn off time (minute)
 '0'-'0' (30h, 30h): 0
 |
 '3'-'B' (33h, 42h): 59 (=3Bh)
 '3'-'C' (33h, 43h): Off timer isn't set.

INPUT: Timer input
 '0'-'0' (30h, 30h): DVI1
 '0'-'7' (30h,30h): No mean (Works on last memory)

WD: Week setting
 bit 0: MONDAY
 bit 1: TUESDAY
 bit 2: WEDNESDAY
 bit 3: THURSDAY
 bit 4: FRIDAY
 bit 5: SATURDAY
 bit 6: SUNDAY

EX.
 '0'-'1' (30h, 31h): MONDAY
 '0'-'4' (30h, 34h): TUESDAY
 '0'-'F' (30h, 46h): MONDAY, TUESDAY, WEDNESDAY and THURSDAY
 '7'-'F' (37h, 46h): MONDAY to SUNDAY

FL: Option
 bit 0: 0:once 1:Everyday
 bit 1: 0:once 1:Every week
 bit 2: 0:Disable 1:Enable

EX.
 '0'-'1' (30h, 31h): Disable, Everyday
 '0'-'4' (30h, 34h): Enable, once

ETX (03h): End of Message

Check code
 BCC: Block Check Code
 Refer to the section 4.3 "Check code" for a BCC calculation.

Delimiter
 CR (0Dh): End of packet

10.2 Schedule Write

This command is used in order to write the setting of the Schedule.

1) The controller requests the monitor to write Schedule.

| Header | Message | Check code | Delimiter |
|------------------------------------|--|------------|-----------|
| SOH-'0'-Monitor ID-'0'-'A'-'2'-'6' | STX-'C'-'2'-'2'-'2'-'2'-PG-ON HOUR-ON MIN-OFF HOUR-OFF MIN-INPUT-WD-FL-P MODE-EXT1-EXT2-EXT3-EXT4-EXT5-EXT6-EXT7-ETX | BCC | CR |

Header

SOH (01h): Start of Header
 '0' (30h): Reserved
 Monitor ID: Specify the Monitor ID of which you want to change a setting.
 Ex.) If Monitor ID is '1', specify 'A'.
 '0' (30h): Message sender is the controller.
 'A' (41h): Message type is "Command".
 '2'-'6' (32h, 36h): Message length.

Message

STX (02h): Start of Message
 'C'-'2'-'2'-'2' (43h, 32h, 32h, 32h): Schedule writes command
 PG-ON HOURS-ON MIN-OFF HOURS-OFF MIN-INPUT-WD-FL-P MODE
 EXT1-EXT2-EXT3-EXT4-EXT5-EXT6-EXT7: Schedule data
 PG: Program No.
 '0'-'0' (30h, 30h): Program No.1
 |
 '0'-'6' (30h, 36h): Program No.7

 ON_HOUR: Turn on time (hour)
 '0'-'0' (30h, 30h): 00
 |
 '1'-'7' (31h, 37h): 23 (=17h)
 '1'-'8' (31h, 38h): ON timer isn't set.

 ON_MIN: Turn on time (minute)
 '0'-'0' (30h, 30h): 0
 |
 '3'-'B' (33h, 42h): 59
 '3'-'C' (33h, 43h): On timer isn't set.

 OFF_HOUR: Turn off time (hour)
 '0'-'0' (30h, 30h): 00
 |
 '1'-'7' (31h, 37h): 23 (=17h)
 '1'-'8' (31h, 38h): Off timer isn't set.

 OFF_MIN: Turn off time (minute)
 '0'-'0' (30h, 30h): 0
 |
 '3'-'B' (33h, 42h): 59 (=3Bh)
 '3'-'C' (33h, 43h): Off timer isn't set.

Note:

- * The same time as ON time and OFF time cannot be set.
- * Set '1'-'8' to ON/OFF_HOUR and '3'-'C' to ON/OFF_MIN, when ON/OFF time is deleted.

INPUT: Timer input

'0'-'0' (30h,30h): No mean (works on last memory)
 '0'-'3' (30h,33h): DVI1
 '0'-'4' (30h,34h): DVI2
 '0'-'D' (30h,44h): OPTION
 '0'-'F' (30h,46h): DPORT
 '1'-'0' (31h,30h): DPORT2
 '1'-'1' (31h,31h): HDMI
 '1'-'2' (31h,32h): HDMI2

'8'-'2' (38h,32h): HDMI3
'8'-'3' (38h,33h): HDMI4
* Please select active input on your system (setting).
* If you select inactive input here, the input change execution will be ignored.

WD: Week setting
bit 0: MONDAY
bit 1: TUESDAY
bit 2: WEDNESDAY
bit 3: THURSDAY
bit 4: FRIDAY
bit 5: SATURDAY
bit 6: SUNDAY

EX.
'0'-'1' (30h, 31h): MONDAY
'0'-'4' (30h, 34h): TUESDAY
'0'-'F' (30h, 46h): MONDAY, TUESDAY, WEDNESDAY and THURSDAY
'7'-'F' (37h, 46h): MONDAY to SUNDAY

FL: Option
bit 0: 0:once 1:Everyday
bit 1: 0:once 1:Every week
bit 2: 0:Disable 1:Enable
* When bit 0 and bit 1 are '1', it behaves as Everyday.

EX.
'0'-'1' (30h, 31h): Disable, Everyday
'0'-'4' (30h, 34h): Enable, once

P MODE: Picture mode
'0'-'0' (30h,30h): No mean (works on last memory)
'0'-'1' (30h,31h): sRGB
'0'-'3' (30h,33h): HIGHBRIGHT
'0'-'4' (30h,34h): STANDARD
'0'-'5' (30h,34h): CINEMA
'0'-'8' (30h,38h): CUSTOM1
'0'-'9' (30h,39h): CUSTOM2
'0'-'D' (30h,44h): SVE-1 SETTING
'0'-'E' (30h,45h): SVE-2 SETTING
'0'-'F' (30h,46h): SVE-3 SETTING
'1'-'0' (31h,30h): SVE-4 SETTING
'1'-'1' (31h,31h): SVE-5 SETTING
* Please select active picture mode on your system (setting).
* If you select inactive picture mode here, the input change execution will be ignored.

EXT1: Extension1
'0'-'0' (30h,30h): (On this monitor, it is always '00')

EXT2: Extension 2
'0'-'0' (30h,30h): (On this monitor, it is always '00')

EXT3: Extension 3
'0'-'0' (30h,30h): (On this monitor, it is always '00')

EXT4: Extension 4
'0'-'0' (30h,30h): (On this monitor, it is always '00')

EXT5: Extension 5
'0'-'0' (30h,30h): (On this monitor, it is always '00')

EXT6: Extension 6
'0'-'0' (30h,30h): (On this monitor, it is always '00')

EXT7: Extension 7
'0'-'0' (30h,30h): (On this monitor, it is always '00')

ETX (03h): End of Message

Check code

BCC: Block Check Code

Refer to the section 4.3 "Check code" for a BCC calculation.

Delimiter

CR (0Dh): End of packet

2) The monitor replies a data for confirmation.

| Header | Message | Check code | Delimiter |
|------------------------------------|---|------------|-----------|
| SOH-'0'-'0'-Monitor ID-'B'-'2'-'8' | STX-'C'-'3'-'2'-'2'-ST-PG-ON HOUR-ON MIN-OFF HOUR-OFF MIN-INPUT-WD-FL-P MODE-EXT1-EXT2-EXT3-EXT4-EXT5-EXT6-EXT7-ETX | BCC | CR |

Header

SOH (01h): Start of Header

'0' (30h): Reserved

'0' (30h): Message receiver is the controller.

Monitor ID: Indicate a replying Monitor ID.

Ex.) When this byte is set to 'A', the replying Monitor ID is '1'.

'B' (42h): Message type is "Command reply".

'2'-'8' (32h, 38h): Message length

Message

STX (02h): Start of Message

'C'-'3'-'2'-'2' (43h, 33h, 32h, 32h): Schedule writes reply command

ST: Schedule Status command

'0'-'0' (30h, 30h): No error

'0'-'1' (30h, 31h): Error

PG-ON HOURS-ON MIN-OFF HOURS-OFF MIN-INPUT-WD-FL-P MODE

EXT1-EXT2-EXT3-EXT4-EXT5-EXT6-EXT7: Schedule data

PG: Program No.

'0'-'0' (30h, 30h): Program No.1

|

'0'-'6' (30h, 36h): Program No.7

ON_HOUR: Turn on time (hour)

'0'-'0' (30h, 30h): 00

|

'1'-'7' (31h, 37h): 23 (=17h)

'1'-'8' (31h, 38h): ON timer isn't set.

ON_MIN: Turn on time (minute)

'0'-'0' (30h, 30h): 0

|

'3'-'B' (33h, 42h): 59

'3'-'C' (33h, 43h): On timer isn't set.

OFF_HOUR: Turn off time (hour)

'0'-'0' (30h, 30h): 00

|

'1'-'7' (31h, 37h): 23 (=17h)

'1'-'8' (31h, 38h): Off timer isn't set.

OFF_MIN: Turn off time (minute)

'0'-'0' (30h, 30h): 0

|

'3'-'B' (33h, 42h): 59 (=3Bh)

'3'-'C' (33h, 43h): Off timer isn't set.

INPUT: Timer input

'0'-'0' (30h,30h): No mean (works on last memory)

'0'-'3' (30h,33h): DVI1

'0'-'4' (30h,34h): DVI2

'0'-'D' (30h,44h): OPTION

'0'-'F' (30h,46h): DPORT

'1'-'0' (31h,30h): DPORT2

'1'-'1' (31h,31h): HDMI
'1'-'2' (31h,32h): HDMI2
'8'-'2' (38h,32h): HDMI3
'8'-'3' (38h,33h): HDMI4

WD: Week setting
bit 0: MONDAY
bit 1: TUESDAY
bit 2: WEDNESDAY
bit 3: THURSDAY
bit 4: FRIDAY
bit 5: SATURDAY
bit 6: SUNDAY

EX.
'0'-'1' (30h, 31h): MONDAY
'0'-'4' (30h, 34h): TUESDAY
'0'-'F' (30h, 46h): MONDAY, TUESDAY, WEDNESDAY and THURSDAY
'7'-'F' (37h, 46h): MONDAY to SUNDAY

FL: Option
bit 0: 0:once 1:Everyday
bit 1: 0:once 1:Every week
bit 2: 0:Disable 1:Enable
* When bit 0 and bit 1 are '1', it behaves as Everyday.

EX.
'0'-'1' (30h, 31h): Disable, Everyday
'0'-'4' (30h, 34h): Enable, once

P MODE: Picture mode
'0'-'0' (30h,30h): No mean (works on last memory)
'0'-'1' (30h,31h): sRGB
'0'-'3' (30h,33h): HIGHBRIGHT
'0'-'4' (30h,34h): STANDARD
'0'-'5' (30h,34h): CINEMA
'0'-'8' (30h,38h): CUSTOM1
'0'-'9' (30h,39h): CUSTOM2
'0'-'D' (30h,44h): SVE-1 SETTING
'0'-'E' (30h,45h): SVE-2 SETTING
'0'-'F' (30h,46h): SVE-3 SETTING
'1'-'0' (31h,30h): SVE-4 SETTING
'1'-'1' (31h,31h): SVE-5 SETTING

EXT1: Extension1
'0'-'0' (30h,30h): (On this monitor, it is always '00')

EXT2: Extension 2
'0'-'0' (30h,30h): (On this monitor, it is always '00')

EXT3: Extension 3
'0'-'0' (30h,30h): (On this monitor, it is always '00')

EXT4: Extension 4
'0'-'0' (30h,30h): (On this monitor, it is always '00')

EXT5: Extension 5
'0'-'0' (30h,30h): (On this monitor, it is always '00')

EXT6: Extension 6
'0'-'0' (30h,30h): (On this monitor, it is always '00')

EXT7: Extension 7
'0'-'0' (30h,30h): (On this monitor, it is always '00')

ETX (03h): End of Message

Check code

BCC: Block Check Code
Refer to the section 4.3 "Check code" for a BCC calculation.

Delimiter
CR (0Dh): End of packet

3) The controller requests the monitor to write Enable/Disable Schedule.

| Header | Message | Check code | Delimiter |
|--|-------------------------------|------------|-----------|
| SOH-'0'-Monitor ID- '0'-'A'-'0'-'A' | STX-'C'-'2'-'1'-'5'-PG-EN-ETX | BCC | CR |

Header

SOH (01h): Start of Header
'0' (30h): Reserved
Monitor ID: Specify the Monitor ID of which you want to change a setting.
Ex.) If Monitor ID is '1', specify 'A'.
'0' (30h): Message sender is the controller.
'A' (41h): Message type is "Command".
'0'-'A'(30h, 41h): Message length

Message

STX (02h): Start of Message
'C'-'2'-'1'-'5' (43h, 32h, 31h, 35h): Enable/Disable Schedule writes command
PG-EN: Enable/Disable Schedule data
PG: Program No.
'0'-'0'(30h, 30h): Program No.1
|
'0'-'6'(30h, 36h): Program No.7

EN: Enable /Disable
'0'-'0'(30h, 30h): Disable
'0'-'1'(30h, 31h): Enable

ETX (03h): End of Message

Check code

BCC: Block Check Code
Refer to the section 4.3 "Check code" for a BCC calculation.

Delimiter
CR (0Dh): End of packet

4) The monitor replies a data for confirmation.

| Header | Message | Check code | Delimiter |
|--|----------------------------------|------------|-----------|
| SOH-'0'-'0'-Monitor ID- 'B'-'0'-'C' | STX-'C'-'3'-'1'-'5'-ST-PG-EN-ETX | BCC | CR |

Header

SOH (01h): Start of Header
'0' (30h): Reserved
'0' (30h): Message receiver is the controller.
Monitor ID: Indicate a replying Monitor ID.
Ex.) When this byte is set to 'A', the replying Monitor ID is '1'.
'B' (42h): Message type is "Command reply".
'0'-'C' (30h, 43h): Message length

Message

STX (02h): Start of Message
'C'-'3'-'1'-'5' (43h, 33h, 31h, 35h): Enable/Disable Schedule writes reply command
ST: Enable/Disable Schedule Status command
'0'-'0'(30h, 30h): No error
'0'-'1'(30h, 31h): Error
PG-EN: Enable/Disable Schedule data
PG: Program No.
'0'-'0'(30h, 30h): Program No.1
|
'0'-'6'(30h, 36h): Program No.7

EN: Enable /Disable
 '0'-'0' (30h, 30h): Disable
 '0'-'1' (30h, 31h): Enable

ETX (03h): End of Message

Check code

BCC: Block Check Code

 Refer to the section 4.3 "Check code" for a BCC calculation.

Delimiter

CR (0Dh): End of packet

*****Following command also can be used for to keep backward compatibility, in order to write the setting of the Schedule.**

1) The controller requests the monitor to write Schedule.

| Header | Message | Check code | Delimiter |
|------------------------------------|--|------------|-----------|
| SOH-'0'-Monitor ID-'0'-'A'-'1'-'6' | STX-'C'-'2'-'1'-'4'-PG-ON HOUR-ON MIN-OFF HOUR-OFF MIN-INPUT-WD-FL-ETX | BCC | CR |

Header

SOH (01h): Start of Header
 '0' (30h): Reserved
 Monitor ID: Specify the Monitor ID of which you want to change a setting.
 Ex.) If Monitor ID is '1', specify 'A'.
 '0' (30h): Message sender is the controller.
 'A' (41h): Message type is "Command".
 '1'-'6' (31h, 36h): Message length.

Message

STX (02h): Start of Message
 'C'-'2'-'1'-'4' (43h, 32h, 31h, 34h): Schedule writes command
 PG-ON HOURS-ON MIN-OFF HOURS-OFF MIN-INPUT-WD-FL: Schedule data
 PG: Program No.
 '0'-'0' (30h, 30h): Program No.1
 |
 '0'-'6' (30h, 36h): Program No.7

 ON_HOUR: Turn on time (hour)
 '0'-'0' (30h, 30h): 00
 |
 '1'-'7' (31h, 37h): 23 (=17h)
 '1'-'8' (31h, 38h): ON timer isn't set.

 ON_MIN: Turn on time (minute)
 '0'-'0' (30h, 30h): 0
 |
 '3'-'B' (33h, 42h): 59
 '3'-'C' (33h, 43h): On timer isn't set.

 OFF_HOUR: Turn off time (hour)
 '0'-'0' (30h, 30h): 00
 |
 '1'-'7' (31h, 37h): 23 (=17h)
 '1'-'8' (31h, 38h): Off timer isn't set.

 OFF_MIN: Turn off time (minute)
 '0'-'0' (30h, 30h): 0
 |
 '3'-'B' (33h, 42h): 59 (=3Bh)
 '3'-'C' (33h, 43h): Off timer isn't set.

 INPUT: Timer input
 '0'-'0' (30h, 30h): DVI1
 '0'-'7' (30h, 37h): (Works on last memory)
 * Please select active input on your system (setting).
 * If you select inactive input here, the input change execution will be ignored.

 WD: Week setting
 bit 0: MONDAY
 bit 1: TUESDAY
 bit 2: WEDNESDAY
 bit 3: THURSDAY
 bit 4: FRIDAY
 bit 5: SATURDAY
 bit 6: SUNDAY

EX.
 '0'-'1' (30h, 31h): MONDAY
 '0'-'4' (30h, 34h): TUESDAY
 '0'-'F' (30h, 46h): MONDAY, TUESDAY, WEDNESDAY and THURSDAY
 '7'-'F' (37h, 46h): MONDAY to SUNDAY

FL: Option
 bit 0: 0:once 1:Everyday
 bit 1: 0:once 1:Every week
 bit 2: 0:Disable 1:Enable
 * When bit 0 and bit 1 are '1', it behaves as Everyday.

EX.
 '0'-'1' (30h, 31h): Disable, Everyday
 '0'-'4' (30h, 34h): Enable, once

ETX (03h): End of Message

Check code

BCC: Block Check Code
 Refer to the section 4.3 "Check code" for a BCC calculation.

Delimiter

CR (0Dh): End of packet

2) The monitor replies a data for confirmation.

| Header | Message | Check code | Delimiter |
|------------------------------------|---|------------|-----------|
| SOH-'0'-'0'-Monitor ID-'B'-'1'-'8' | STX-'C'-'3'-'1'-'4'-ST-PG-ON HOUR-ON MIN-OFF HOUR-OFF MIN-INPUT-WD-FL-ETX | BCC | CR |

Header

SOH (01h): Start of Header
 '0' (30h): Reserved
 '0' (30h): Message receiver is the controller.
 Monitor ID: Indicate a replying Monitor ID.
 Ex.) When this byte is set to 'A', the replying Monitor ID is '1'.
 'B' (42h): Message type is "Command reply".
 '1'-'8' (31h, 38h): Message length

Message

STX (02h): Start of Message
 'C'-'3'-'1'-'4' (43h, 33h, 31h, 34h): Schedule writes reply command
 ST: Schedule Status command
 '0'-'0' (30h, 30h): No error
 '0'-'1' (30h, 31h): Error
 PG-ON HOURS-ON MIN-OFF HOURS-OFF MIN-INPUT-WD-FL: Schedule data
 PG: Program No.
 '0'-'0' (30h, 30h): Program No.1
 |
 '0'-'6' (30h, 36h): Program No.7
 ON_HOUR: Turn on time (hour)
 '0'-'0' (30h, 30h): 00
 |
 '1'-'7' (31h, 37h): 23 (=17h)
 '1'-'8' (31h, 38h): ON timer isn't set.
 ON_MIN: Turn on time (minute)
 '0'-'0' (30h, 30h): 0
 |
 '3'-'B' (33h, 42h): 59
 '3'-'C' (33h, 43h): On timer isn't set.
 OFF_HOUR: Turn off time (hour)
 '0'-'0' (30h, 30h): 00
 |

'1'-'7'(31h, 37h): 23 (=17h)
'1'-'8'(31h, 38h): Off timer isn't set.

OFF_MIN: Turn off time (minute)
'0'-'0'(30h, 30h): 0
|
'3'-'B'(33h, 42h): 59 (=3Bh)
'3'-'C'(33h, 43h): Off timer isn't set.

INPUT: Timer input
'0'-'0'(30h, 30h): DVI1
'0'-'7'(30h,30h): No mean (Works on last memory)

WD: Week setting
bit 0: MONDAY
bit 1: TUESDAY
bit 2: WEDNESDAY
bit 3: THURSDAY
bit 4: FRIDAY
bit 5: SATURDAY
bit 6: SUNDAY

EX.
'0'-'1'(30h, 31h): MONDAY
'0'-'4'(30h, 34h): TUESDAY
'0'-'F'(30h, 46h): MONDAY, TUESDAY, WEDNESDAY and THURSDAY
'7'-'F'(37h, 46h): MONDAY to SUNDAY

FL: Option
bit 0: 0:once 1:Everyday
bit 1: 0:once 1:Every week
bit 2: 0:Disable 1:Enable
* When bit 0 and bit 1 are '1', it behaves as Everyday.

EX.
'0'-'1'(30h, 31h): Disable, Everyday
'0'-'4'(30h, 34h): Enable, once

ETX (03h): End of Message

Check code
BCC: Block Check Code
Refer to the section 4.3 "Check code" for a BCC calculation.

Delimiter
CR (0Dh): End of packet

3) The controller requests the monitor to write Enable/Disable Schedule.

| Header | Message | Check code | Delimiter |
|--|-------------------------------|------------|-----------|
| SOH-'0'-Monitor ID- '0'-'A'-'0'-'A' | STX-'C'-'2'-'1'-'5'-PG-EN-ETX | BCC | CR |

Header
SOH (01h): Start of Header
'0' (30h): Reserved
Monitor ID: Specify the Monitor ID of which you want to change a setting.
Ex.) If Monitor ID is '1', specify 'A'.
'0' (30h): Message sender is the controller.
'A' (41h): Message type is "Command".
'0'-'A'(30h, 41h): Message length

Message
STX (02h): Start of Message
'C'-'2'-'1'-'5' (43h, 32h, 31h, 35h): Enable/Disable Schedule writes command
PG-EN: Enable/Disable Schedule data
PG: Program No.
'0'-'0'(30h, 30h): Program No.1
|

'0'-'6' (30h, 36h): Program No.7

EN: Enable /Disable
'0'-'0' (30h, 30h): Disable
'0'-'1' (30h, 31h): Enable

ETX (03h): End of Message

Check code

BCC: Block Check Code
Refer to the section 4.3 "Check code" for a BCC calculation.

Delimiter

CR (0Dh): End of packet

4) The monitor replies a data for confirmation.

| Header | Message | Check code | Delimiter |
|--|----------------------------------|------------|-----------|
| SOH-'0'-'0'-Monitor ID- 'B'-'0'-'C' | STX-'C'-'3'-'1'-'5'-ST-PG-EN-ETX | BCC | CR |

Header

SOH (01h): Start of Header
'0' (30h): Reserved
'0' (30h): Message receiver is the controller.
Monitor ID: Indicate a replying Monitor ID.
Ex.) When this byte is set to 'A', the replying Monitor ID is '1'.
'B' (42h): Message type is "Command reply".
'0'-'C' (30h, 43h): Message length

Message

STX (02h): Start of Message
'C'-'3'-'1'-'5' (43h, 33h, 31h, 35h): Enable/Disable Schedule writes reply command
ST: Enable/Disable Schedule Status command
'0'-'0' (30h, 30h): No error
'0'-'1' (30h, 31h): Error
PG-EN: Enable/Disable Schedule data
PG: Program No.
'0'-'0' (30h, 30h): Program No.1
|
'0'-'6' (30h, 36h): Program No.7

EN: Enable /Disable
'0'-'0' (30h, 30h): Disable
'0'-'1' (30h, 31h): Enable

ETX (03h): End of Message

Check code

BCC: Block Check Code
Refer to the section 4.3 "Check code" for a BCC calculation.

Delimiter

CR (0Dh): End of packet

11. Self diagnosis

11.1 Self-diagnosis status read

This command is used in order to read the Self-diagnosis status.

- 1) The controller requests the monitor to read Self-diagnosis status.

| Header | Message | Check code | Delimiter |
|------------------------------------|-----------------|------------|-----------|
| SOH-'0'-Monitor ID-'0'-'A'-'0'-'4' | STX-'B'-'1'-ETX | BCC | CR |

Header

SOH (01h): Start of Header
'0' (30h): Reserved
Monitor ID: Specify the Monitor ID which you want to get status.
Ex.) If Monitor ID is '1', specify 'A'.
'0' (30h): Message sender is the controller.
'A' (41h): Message type is "Command".
'0'-'4'(30h, 34h): Message length

Message

STX (02h): Start of Message
'B'-'1' (42h, 31h): Self-diagnosis command
ETX (03h): End of Message

Check code

BCC: Block Check Code
Refer to the section 4.3 "Check code" for a BCC calculation.

Delimiter

CR (0Dh): End of packet

- 2) The monitor replies a result of the self-diagnosis.

| Header | Message | Check code | Delimiter |
|----------------------------------|--|------------|-----------|
| SOH-'0'-'0'-Monitor ID-'B'-'N'-N | STX-'A'-'1'- ST(0)-ST(1) -----ST(n)-ETX | BCC | CR |

Header

SOH (01h): Start of Header
'0' (30h): Reserved
'0' (30h): Message receiver is the controller.
Monitor ID: Indicate a replying Monitor ID.
Ex.) When this byte is set to 'A', the replying Monitor ID is '1'.
'B' (42h): Message type is "Command reply".
N-N: Message length
Note.) The maximum data length that can be written to the monitor at a time is 32bytes.
Ex.) The byte data 20h is encoded as ASCII characters '2' and '0' (34h and 30h).

Message

STX (02h): Start of Message
'A'-'1' (41h, 31h): Application Test Report reply command
ST: Result of self-tests
'0'-'0'(30h, 30h):00: Normal
'7'-'0'(37h, 30h):70: Standby-power +3.3V abnormality
'7'-'1'(37h, 31h):71: Standby-power +5V abnormality
'7'-'2'(37h, 32h):72: Panel-power +12V abnormality
'7'-'8'(37h, 38h):78: Inverter power/Option slot2 power +24V Abnormality
'8'-'0'(38h, 30h):80: Cooling fan-1 abnormality
'8'-'1'(38h, 31h):81: Cooling fan-2 abnormality
'8'-'2'(38h, 32h):82: Cooling fan-3 abnormality
'9'-'0'(39h, 30h):90: LED Backlight abnormality
'9'-'1'(39h, 31h):91: LED Backlight abnormality
'A'-'0'(41h, 30h):A0: Temperature abnormality - shutdown
'A'-'1'(41h, 31h):A1: Temperature abnormality - half brightness
'A'-'2'(41h, 32h):A2: SENSOR reached at the temperature that the user had specified.

'B'-'0'(42h, 30h):B0: No signal
'D'-'0'(44h, 30h):D0: PROOF OF PLAY buffer reduction
'E'-'0'(45h, 30h):E0: System error

ETX (03h): End of Message

Check code

BCC: Block Check Code

Refer to the section 4.3 "Check code" for a BCC calculation.

Delimiter

CR (0Dh): End of packet

12. Serial No. & Model Name Read

12.1 Serial No. Read

This command is used in order to read a serial number.

- 1) The controller requests the monitor to read a serial number.

| Header | Message | Check code | Delimiter |
|------------------------------------|-------------------------|------------|-----------|
| SOH-'0'-Monitor ID-'0'-'A'-'0'-'6' | STX-'C'-'2'-'1'-'6'-ETX | BCC | CR |

Header

SOH (01h): Start of Header
 '0' (30h): Reserved
 Monitor ID: Specify the Monitor ID which you want to get serial number.
 Ex.) If Monitor ID is '1', specify 'A'.
 '0' (30h): Message sender is the controller.
 'A' (41h): Message type is "Command".
 '0'-'6' (30h, 36h): Message length

Message

STX (02h): Start of Message
 'C'-'2'-'1'-'6' (43h, 32h, 31h, 36h): Serial No. command
 ETX (03h): End of Message

Check code

BCC: Block Check Code
 Refer to the section 4.3 "Check code" for a BCC calculation.

Delimiter

CR (0Dh): End of packet

- 2) The monitor replies the serial No. data to the controller.

| Header | Message | Check code | Delimiter |
|----------------------------------|---|------------|-----------|
| SOH-'0'-'0'-Monitor ID-'B'-'N'-N | STX-'C'-'3'-'1'-'6'-Data(0)-Data(1)---Data(n)-ETX | BCC | CR |

Header

SOH (01h): Start of Header
 '0' (30h): Reserved
 '0' (30h): Message receiver is the controller.
 Monitor ID: Indicate a replying Monitor ID.
 Ex.) When this byte is set to 'A', the replying Monitor ID is '1'.
 'B' (42h): Message type is "Command reply".
 N-N: Message length
 Note.) The maximum data length that can be returned from the monitor at a time is 32bytes.
 Ex.) The byte data 20h is encoded as ASCII characters '2' and '0' (32h and 30h).

Message

STX (02h): Start of Message
 'C'-'3'-'1'-'6' (41h, 33h, 31h, 36h): Serial No. reply command
 Data(0)-Data(1)----Data(n):Serial Number
 ➤ The byte data 20h is encoded as ASCII characters '2' and '0' (32h and 30h).
 Ex.) For example when receiving Serial Number data 33h 31h 33h 32h 33h 33h 34h
 Step1: Serial Number data is encoded as character string.
 Example:
 33h 31h 33h 32h 33h 33h 34h -> '3','1','3','2','3','3','3','4'
 Step2: Decode pairs of ASCII characters to hexadecimal values.
 Example:
 '3','1','3','2','3','3','3','4' -> 31h 32h 33h 34h
 Step3: Byte data represents the ASCII string data.
 Example:
 31h 32h 33h 34h -> "1234"
 Result: Serial Number is "1234".

Note: No null termination character is sent.

ETX (03h): End of Message

Check code

BCC: Block Check Code

Refer to the section 4.3 "Check code" for a BCC calculation.

Delimiter

CR (0Dh): End of packet

12.2 Model Name Read

This command is used in order to read the Model Name.

- 1) The controller requests the monitor to read Model Name.

| Header | Message | Check code | Delimiter |
|------------------------------------|-------------------------|------------|-----------|
| SOH-'0'-Monitor ID-'0'-'A'-'0'-'6' | STX-'C'-'2'-'1'-'7'-ETX | BCC | CR |

Header

SOH (01h): Start of Header
 '0' (30h): Reserved
 Monitor ID: Specify the Monitor ID which you want to get Model Name.
 Ex.) If Monitor ID is '1', specify 'A'.
 '0' (30h): Message sender is the controller.
 'A' (41h): Message type is "Command".
 '0'-'6' (30h, 36h): Message length

Message

STX (02h): Start of Message
 'C'-'2'-'1'-'7' (43h, 32h, 31h, 37h): Model Name command
 ETX (03h): End of Message

Check code

BCC: Block Check Code
 Refer to the section 4.3 "Check code" for a BCC calculation.

Delimiter

CR (0Dh): End of packet

- 2) The monitor replies the model name data to the controller.

| Header | Message | Check code | Delimiter |
|------------------------------------|---|------------|-----------|
| SOH-'0'-'0'-Monitor ID-'B'-'N'-'N' | STX-'C'-'3'-'1'-'7'-Data(0) -Data(1)----Data(n)-ETX | BCC | CR |

Header

SOH (01h): Start of Header
 '0' (30h): Reserved
 '0' (30h): Message receiver is the controller.
 Monitor ID: Indicate a replying Monitor ID.
 Ex.) When this byte is set to 'A', the replying Monitor ID is '1'.
 'B' (42h): Message type is "Command reply".
 N-N: Message length
 Note.) The maximum data length that can be returned from the monitor at a time is 32bytes.
 Ex.) The byte data 20h is encoded as ASCII characters '2' and '0' (32h and 30h).

Message

STX (02h): Start of Message
 'C'-'3'-'1'-'7' (43h, 33h, 31h, 37h): Model Name reply Command
 Data(0) -Data(1)----Data(n):Model name
 ➤ The byte data 20h is encoded as ASCII characters '2' and '0' (32h and 30h).
 Ex.) For example when receiving Model Name data 35h 30h 33h 34h 33h 30h 33h 33h
 Step1: Model Name data is encoded character string.
 Example:
 35h 30h 33h 34h 33h 30h 33h 33h -> '5','0','3','4','3','0','3','3'
 Step2: Decode pairs of ASCII characters to hexadecimal values.
 Example:
 '5','0','3','4','3','0','3','3' -> 50h 34h 30h 33h
 Step3: Byte data represents the ASCII string data.
 Example:
 50h 34h 30h 33h -> "P403"
 Result: Model Name is "P403".
 Note: No null termination character is sent.
 ETX (03h): End of Message

Check code

BCC: Block Check Code

Refer to the section 4.3 "Check code" for a BCC calculation.

Delimiter

CR (0Dh): End of packet

13. Security Lock

13.1 Security Lock Control

This command sets the condition of security lock function to "LOCK" or "UNLOCK".

If security pass codes 1st to 4th are matched with monitor resisted pass codes, then this command is executed, and reply no error status and a new condition.

If codes aren't matched with them then setting isn't changed, and reply error status and a current condition.

If the monitor receives this command while waiting for Pass codes inputs, then it only checks Pass cords (and releases image muting if Pass codes are OK) and doesn't apply "EN" parameter.

1) The controller requests the monitor to set the condition of security lock.

| Header | Message | Check code | Delimiter |
|-----------------------------------|--|------------|-----------|
| SOH-'0'-MonitorID-'0'-'A'-'1'-'0' | STX-'C'-'2'-'1'-'D'-EN-P1-P2-P3-P4-ETX | BCC | CR |

Header

SOH (01h): Start of Header

'0' (30h): Reserved

Monitor ID: Specify the Monitor ID of which you want to change a setting.
Ex.) If Monitor ID is '1', specify 'A'.

'0' (30h): Message sender is the controller.

'A' (41h): Message type is "Command".

'1'-'0' (31h, 30h): Message length

Message

STX (02h): Start of Message

'C'-'2'-'1'-'D' (43h, 32h, 31h, 44h): Security Lock Control command

EN-P1-P2-P3-P4: Lock condition control data

EN: SECURE MODE

'0'-'0' (30h, 30h): OFF

'0'-'1' (30h, 31h): START-UP LOCK

'0'-'2' (30h, 32h): CONTROL LOCK

'0'-'3' (30h, 33h): BOTH LOCK

P1: Security Pass code 1st

'0'-'0' (30h, 30h): "0"

|

'0'-'9' (30h, 39h): "9"

P2: Security Pass code 2nd

'0'-'0' (30h, 30h): "0"

|

'0'-'9' (30h, 39h): "9"

P3: Security Pass code 3rd

'0'-'0' (30h, 30h): "0"

|

'0'-'9' (30h, 39h): "9"

P4: Security Pass code 4th

'0'-'0' (30h, 30h): "0"

|

'0'-'9' (30h, 39h): "9"

ETX (03h): End of Message

Check code

BCC: Block Check Code

Refer to the section 4.3 "Check code" for a BCC calculation.

Delimiter

CR (0Dh): End of packet

2) The monitor replies the result to the controller.

| Header | Message | Check code | Delimiter |
|--|-----------------------------------|------------|-----------|
| SOH-'0'-'0'-Monitor ID- 'B'-'0'-'A' | STX-'C'-'3'-'1'-'D'- ST-EN-ETX | BCC | CR |

Header

SOH (01h): Start of Header
 '0' (30h): Reserved
 '0' (30h): Message receiver is the controller.
 Monitor ID: Indicate a replying Monitor ID.
 Ex.) When this byte is set to 'A', the replying Monitor ID is '1'.
 'B' (42h): Message type is "Command reply".
 '0'-'A'(30h, 41h): Message length

Message

STX (02h): Start of Message
 'C'-'3'-'1'-'D' (43h, 33h, 31h, 44h): Security Lock Control reply command
 ST-EN: Lock condition result data
 ST: Status
 '0'-'0'(30h, 30h): No error
 '0'-'1'(30h, 31h): Error

 EN: SECURE MODE (Current condition)
 '0'-'0'(30h, 30h): OFF
 '0'-'1'(30h, 31h): START-UP LOCK
 '0'-'2'(30h, 32h): CONTROL LOCK
 '0'-'3'(30h, 33h): BOTH LOCK

ETX (03h): End of Message

Check code

BCC: Block Check Code
 Refer to the section 4.3 "Check code" for a BCC calculation.

Delimiter

CR (0Dh): End of packet

14. Direct TV Chanel Read & Write

When DTV unit (Option unit) is installed, channel settings is read and write directly.

14.1 Direct TV Chanel Read & Reply

- 1) The controller requests the monitor to read channel information.

| Header | Message | Check code | Delimiter |
|------------------------------------|-------------------------|------------|-----------|
| SOH-'0'-Monitor ID-'0'-'A'-'0'-'6' | STX-'C'-'2'-'2'-'C'-ETX | BCC | CR |

Header

SOH (01h): Start of Header
 '0' (30h): Reserved
 Monitor ID: Specify the Monitor ID which you want to get Model Name.
 Ex.) If Monitor ID is '1', specify 'A'.
 '0' (30h): Message sender is the controller.
 'A' (41h): Message type is "Command".
 '0'-'6'(30h, 36h): Message length

Message

STX (02h): Start of Message
 'C'-'2'-'2'-'C' (43h, 32h, 32h, 43h): Direct TV Channel Read command
 ETX (03h): End of Message

Check code

BCC: Block Check Code
 Refer to the section 4.3 "Check code" for a BCC calculation.

Delimiter

CR (0Dh): End of packet

- 2) The monitor replies the result to the controller.

| Header | Message | Check code | Delimiter |
|------------------------------------|---|------------|-----------|
| SOH-'0'-'0'-Monitor ID-'B'-'1'-'2' | STX-'C'-'3'-'2'-'C'-MajorCH-MinorCH-ETX | BCC | CR |

Header

SOH (01h): Start of Header
 '0' (30h): Reserved
 '0' (30h): Message receiver is the controller.
 Monitor ID: Indicate a replying Monitor ID.
 Ex.) When this byte is set to 'A', the replying Monitor ID is '1'.
 'B' (42h): Message type is "Command reply".
 '1'-'2'(31h, 32h): Message length = 18bytes

Message

STX (02h): Start of Message
 'C'-'3'-'2'-'C' (43h, 33h, 32h, 43h): Direct TV Channel read reply command
 MajorCH: Major Channel (00000000h - FFFFFFFFh),
 '0'-'0'-'0'-'0'-'0'-'0'-'0'-'0' - 'F'-'F'-'F'-'F'-'F'-'F'-'F'-'F'
 MinorCH: Minor Channel (0000h - FFFFh),
 '0'-'0'-'0'-'0' - 'F'-'F'-'F'-'F'
 ETX (03h): End of Message

Check code

BCC: Block Check Code
 Refer to the section 4.3 "Check code" for a BCC calculation.

Delimiter

CR (0Dh): End of packet

14.2 Direct TV Chanel Write & Reply

- 1) The controller requests the monitor to write channel information.

| Header | Message | Check code | Delimiter |
|------------------------------------|---|------------|-----------|
| SOH-'0'-Monitor ID-'0'-'A'-'1'-'2' | STX-'C'-'2'-'2'-'D'-MajorCH-MinorCH-ETX | BCC | CR |

Header

SOH (01h): Start of Header
 '0' (30h): Reserved
 Monitor ID: Specify the Monitor ID which you want to get Model Name.
 Ex.) If Monitor ID is '1', specify 'A'.
 '0' (30h): Message sender is the controller.
 'A' (41h): Message type is "Command".
 '1'-'2'(31h, 32h): Message length = 18bytes

Message

STX (02h): Start of Message
 'C'-'2'-'2'-'D' (43h, 32h, 32h, 44h): Direct TV Channel write command
 MajorCH: Major Channel (00000000h - FFFFFFFFh),
 '0'-'0'-'0'-'0'-'0'-'0'-'0'-'0' - 'F'-'F'-'F'-'F'-'F'-'F'-'F'-'F'
 MinorCH: Minor Channel (0000h - FFFFh),
 '0'-'0'-'0'-'0' - 'F'-'F'-'F'-'F'
 ETX (03h): End of Message

Check code

BCC: Block Check Code
 Refer to the section 4.3 "Check code" for a BCC calculation.

Delimiter

CR (0Dh): End of packet

- 2) The monitor replies the result to the controller.

| Header | Message | Check code | Delimiter |
|------------------------------------|---|------------|-----------|
| SOH-'0'-'0'-Monitor ID-'B'-'1'-'2' | STX-'C'-'3'-'2'-'D'-MajorCH-MinorCH-ETX | BCC | CR |

Header

SOH (01h): Start of Header
 '0' (30h): Reserved
 '0' (30h): Message receiver is the controller.
 Monitor ID: Indicate a replying Monitor ID.
 Ex.) When this byte is set to 'A', the replying Monitor ID is '1'.
 'B' (42h): Message type is "Command reply".
 '1'-'2'(31h, 32h): Message length = 18bytes

Message

STX (02h): Start of Message
 'C'-'3'-'2'-'D' (43h, 33h, 32h, 43h): Direct TV Channel write reply command
 MajorCH: Major Channel (00000000h - FFFFFFFFh),
 '0'-'0'-'0'-'0'-'0'-'0'-'0'-'0' - 'F'-'F'-'F'-'F'-'F'-'F'-'F'-'F'
 MinorCH: Minor Channel (0000h - FFFFh),
 '0'-'0'-'0'-'0' - 'F'-'F'-'F'-'F'
 ETX (03h): End of Message

Check code

BCC: Block Check Code
 Refer to the section 4.3 "Check code" for a BCC calculation.

Delimiter

CR (0Dh): End of packet

15. Daylight Saving read & write

15.1 Daylight Saving Read

This command is used in order to read the setting of Daylight Saving.

- 1) The controller requests the monitor to reply a Daylight Saving setting.

| Header | Message | Check code | Delimiter |
|------------------------------------|---------------------------------|------------|-----------|
| SOH-'0'-Monitor ID-'0'-'A'-'0'-'8' | STX-'C'-'A'-'0'-'1'-'0'-'0'-ETX | BCC | CR |

Header

SOH (01h): Start of Header
'0' (30h): Reserved
Monitor ID: Specify the Monitor ID of which you want to change a setting.
 Ex.) If Monitor ID is '1', specify 'A'.
'0' (30h): Message sender is the controller.
'A' (41h): Message type is "Command".
'0'-'8' (30h, 38h): Message length (8bytes)

Message

STX (02h): Start of Message
'C'-'A'-'0'-'1' (43h, 41h, 30h, 31h): Daylight Saving Command
'0'-'0' (30h, 30h): Read
ETX (03h): End of Message

Check code

BCC: Block Check Code
 Refer to the section 4.3 "Check code" for a BCC calculation.

Delimiter

CR (0Dh): End of packet

- 2) The monitor replies Date & Time to the controller.

| Header | Message | Check code | Delimiter |
|------------------------------------|--|------------|-----------|
| SOH-'0'-'0'-Monitor ID-'B'-'2'-'0' | STX-'C'-'B'-'0'-'1'-'0'-'0'-ST-BM-BD1-BD-BT1-BT2-EM-ED1-ED2-ET1-ET2-TD-ETX | BCC | CR |

Header

SOH (01h): Start of Header
'0' (30h): Reserved
'0' (30h): Message receiver is the controller.
Monitor ID: Indicate a replying Monitor ID.
 Ex.) When this byte is set to 'A', replying monitor's ID is '1'.
'B' (42h): Message type is "Command reply".
'2'-'0' (32h, 30h): Message length (32bytes)

Message

STX (02h): Start of Message
'C'-'B'-'0'-'1' (43h, 42h, 30h, 31h): Daylight Saving Setting reply command
'0'-'0' (30h, 30h): Read
ST: Error Status
 No Error : 00h (30h, 30h)
 Error : 01h (30h, 31h)
BM: BEGIN MONTH
 JANUARY - DECEMBER: 01h (30h, 31h) - 12h (31h, 32h)
BD1: BEGIN DAY1
 FIRST : 01h (30h, 31h)
 SECOND : 02h (30h, 32h)
 THIRD : 03h (30h, 33h)
 FOUR : 04h (30h, 34h)

```

    LAST      : 05h (30h, 35h)
BD2: BEGIN DAY2 (Day of the week)
    SUNDAY    : 01h (30h, 31h)
    MONDAY    : 02h (30h, 32h)
    TUESDAY   : 03h (30h, 33h)
    WEDNESDAY : 04h (30h, 34h)
    THURSDAY  : 05h (30h, 35h)
    FRIDAY    : 06h (30h, 36h)
    SATURDAY  : 07h (30h, 37h)
BT1: BEGIN TIME1 (Hour)
    00h (30h, 30h) - 23 (32h, 33h)
BT2: BEGIN TIME2 (Minute)
    00h (30h, 30h) - 59 (35h, 39h)
EM: END MONTH
    JANUARY - DECEMBER: 01h (30h, 31h) - 12h (31h, 32h)
ED1: END DAY1
    FIRST     : 01h (30h, 31h)
    SECOND    : 02h (30h, 32h)
    THIRD     : 03h (30h, 33h)
    FOUR      : 04h (30h, 34h)
    LAST      : 05h (30h, 35h)
ED2: END DAY2 (Day of the week)
    SUNDAY    : 01h (30h, 31h)
    MONDAY    : 02h (30h, 32h)
    TUESDAY   : 03h (30h, 33h)
    WEDNESDAY : 04h (30h, 34h)
    THURSDAY  : 05h (30h, 35h)
    FRIDAY    : 06h (30h, 36h)
    SATURDAY  : 07h (30h, 37h)
ET1: END TIME1 (Hour)
    00h (30h, 30h) - 23 (32h, 33h)
ET2: END TIME2 (Minute)
    00h (30h, 30h) - 59 (35h, 39h)
TD: TIME DIFFERENCE
    +01:00    : 00h (30h, 30h)
    +00:30    : 01h (30h, 31h)
    -00:30    : 02h (30h, 32h)
    -01:00    : 03h (30h, 33h)
ETX (03h): End of Message

```

Check code

BCC: Block Check Code

Refer to the section 4.3 "Check code" for a BCC calculation.

Delimiter

CR (0Dh): End of packet

15.2 Daylight Saving Write

This command is used in order to write the setting of the Daylight Saving.

- 1) The controller requests the monitor to write Daylight Saving.

| Header | Message | Check code | Delimiter |
|------------------------------------|--|------------|-----------|
| SOH-'0'-Monitor ID-'0'-'A'-'1'-'E' | STX-'C'-'A'-'0'-'1'-'0'-'1'-BM-BD1-BD2-BT1-BT2-EM-ED1-ED2-ET1-ET2-TD-ETX | BCC | CR |

Header

SOH (01h): Start of Header
 '0' (30h): Reserved
 Monitor ID: Specify the Monitor ID of which you want to change a setting.
 Ex.) If Monitor ID is '1', specify 'A'.
 '0' (30h): Message sender is the controller.
 'A' (41h): Message type is "Command".
 '1'-'E' (31h, 45h): Message length (30bytes)

Message

STX (02h): Start of Message
 'C'-'A'-'0'-'1' (43h, 41h, 30h, 31h): Daylight Saving Setting Command
 '0'-'1' (30h, 31h): Write
 BM: BEGIN MONTH
 JANUARY - DECEMBER: 01h (30h, 31h) - 12h (31h, 32h)
 BD1: BEGIN DAY1
 FIRST : 01h (30h, 31h)
 SECOND : 02h (30h, 32h)
 THIRD : 03h (30h, 33h)
 FOUR : 04h (30h, 34h)
 LAST : 05h (30h, 35h)
 BD2: BEGIN DAY2 (Day of the week)
 SUNDAY : 01h (30h, 31h)
 MONDAY : 02h (30h, 32h)
 TUESDAY : 03h (30h, 33h)
 WEDNESDAY : 04h (30h, 34h)
 THURSDAY : 05h (30h, 35h)
 FRIDAY : 06h (30h, 36h)
 SATURDAY : 07h (30h, 37h)
 BT1: BEGIN TIME1 (Hour)
 00h (30h, 30h) - 23 (32h, 33h)
 BT2: BEGIN TIME2 (Minute)
 00h (30h, 30h) - 59 (35h, 39h)
 EM: END MONTH
 JANUARY - DECEMBER: 01h (30h, 31h) - 12h (31h, 32h)
 ED1: END DAY1
 FIRST : 01h (30h, 31h)
 SECOND : 02h (30h, 32h)
 THIRD : 03h (30h, 33h)
 FOUR : 04h (30h, 34h)
 LAST : 05h (30h, 35h)
 ED2: END DAY2 (Day of the week)
 SUNDAY : 01h (30h, 31h)
 MONDAY : 02h (30h, 32h)
 TUESDAY : 03h (30h, 33h)
 WEDNESDAY : 04h (30h, 34h)
 THURSDAY : 05h (30h, 35h)
 FRIDAY : 06h (30h, 36h)
 SATURDAY : 07h (30h, 37h)
 ET1: END TIME1 (Hour)
 00h (30h, 30h) - 23 (32h, 33h)
 ET2: END TIME2 (Minute)
 00h (30h, 30h) - 59 (35h, 39h)
 TD: TIME DIFFERENCE

+01:00 : 00h (30h, 30h)
 +00:30 : 01h (30h, 31h)
 -00:30 : 02h (30h, 32h)
 -01:00 : 03h (30h, 33h)
 ETX (03h): End of Message

Check code

BCC: Block Check Code

Refer to the section 4.3 "Check code" for a BCC calculation.

Delimiter

CR (0Dh): End of packet

2) The monitor replies a written in result.

| Header | Message | Check code | Delimiter |
|--|------------------------------------|------------|-----------|
| SOH-'0'-'0'-Monitor ID- 'B'-'0'-'A' | STX-'C'-'B'-'0'-'1'-'0'-'1'-ST-ETX | BCC | CR |

Header

SOH (01h): Start of Header

'0' (30h): Reserved

'0' (30h): Message receiver is the controller.

Monitor ID: Indicate a replying Monitor ID.

Ex.) When this byte is set to 'A', replying monitor's ID is '1'.

'B' (42h): Message type is "Command reply".

'0'-'A'(30h, 41h): Message length (10bytes)

Message

STX (02h): Start of Message

'C'-'B'-'0'-'1' (43h, 42h, 30h, 31h): Daylight Saving Setting Command

'0'-'1' (30h, 31h): Write

ST: Error Status

No Error : 00h (30h, 30h)

Error : 01h (30h, 31h)

ETX (03h): End of Message

Check code

BCC: Block Check Code

Refer to the section 4.3 "Check code" for a BCC calculation.

Delimiter

CR (0Dh): End of packet

16. Firmware Version

16.1 Firmware Version Read

This command is used in order to read a firmware version.

- 1) The controller requests the monitor to reply a firmware version.

| Header | Message | Check code | Delimiter |
|------------------------------------|----------------------------|------------|-----------|
| SOH-'0'-Monitor ID-'0'-'A'-'0'-'8' | STX-'C'-'A'-'0'-'2'-TY-ETX | BCC | CR |

Header

SOH (01h): Start of Header
'0' (30h): Reserved
Monitor ID: Specify the Monitor ID of which you want to change a setting.
Ex.) If Monitor ID is '1', specify 'A'.
'0' (30h): Message sender is the controller.
'A' (41h): Message type is "Command".
'0'-'8' (30h, 38h): Message length (8bytes)

Message

STX (02h): Start of Message
'C'-'A'-'0'-'2' (43h, 41h, 30h, 32h): Firmware Version Command
TY: Firmware Type
Firmware1: 00h (30h, 30h)
Firmware2: 01h (30h, 31h)
Firmware3: 02h (30h, 32h)
Firmware4: 03h (30h, 33h)
ETX (03h): End of Message

Check code

BCC: Block Check Code
Refer to the section 4.3 "Check code" for a BCC calculation.

Delimiter

CR (0Dh): End of packet

- 2) The monitor replies a firmware version to the controller.

| Header | Message | Check code | Delimiter |
|------------------------------------|---|------------|-----------|
| SOH-'0'-Monitor ID-'0'-'B'-'1'-'1' | STX-'C'-'B'-'0'-'2'-ST-TY-MV-PP-BV1-BV2-BV3-BR1-BR2-ETX | BCC | CR |

Header

SOH (01h): Start of Header
'0' (30h): Reserved
'0' (30h): Message receiver is the controller.
Monitor ID: Indicate a replying Monitor ID.
Ex.) When this byte is set to 'A', replying monitor's ID is '1'.
'B' (42h): Message type is "Command reply".
'1'-'1' (31h, 31h): Message length (17bytes)

Message

STX (02h): Start of Message
'C'-'B'-'0'-'2' (43h, 42h, 30h, 32h): Firmware Version Read reply
ST: Error Status
No Error : 00h (30h, 30h)
Error : 01h (30h, 31h)
TY: Firmware Type
Firmware1: 00h (30h, 30h)
Firmware2: 01h (30h, 31h)
MV: Major Version:

00h (30h, 30h) - 09h (30h, 39h)
PP: Period:
2Eh (32h, 45h) (fixed)
BV1: Minor (Basic) Version1:
00h (30h, 30h) - 09h (30h, 39h)
BV2: Minor (Basic) Version2:
00h (30h, 30h) - 09h (30h, 39h)
BV3: Minor (Basic) Version3:
00h (30h, 30h) - 09h (30h, 39h)
BR1: Branch Version1:
A:41h (34h, 31h) - Z:5Ah (35h, 41h)
BR2: Branch Version1:
A:41h (34h, 31h) - Z:5Ah (35h, 41h)

Check code

BCC: Block Check Code
Refer to the section 4.3 "Check code" for a BCC calculation.

Delimiter

CR (0Dh): End of packet

17. Auto ID

17.1 Auto ID Execute

This command is used in order to execute Auto ID function.

- 1) The controller requests the monitor to execute Auto ID function.

| Header | Message | Check code | Delimiter |
|------------------------------------|---------------------------------|------------|-----------|
| SOH-'0'-Monitor ID-'0'-'A'-'0'-'8' | STX-'C'-'A'-'0'-'A'-'0'-'1'-ETX | BCC | CR |

Header

SOH (01h): Start of Header
'0' (30h): Reserved
Monitor ID: Specify the Monitor ID of which you want to change a setting.
Ex.) If Monitor ID is '1', specify 'A'.
'0' (30h): Message sender is the controller.
'A' (41h): Message type is "Command".
'0'-'8' (30h, 38h): Message length (8byte)

Message

STX (02h): Start of Message
'C'-'A'-'0'-'A' (43h, 41h, 30h, 41h, 30h, 31h): Auto ID Command
'0'-'1' (30h, 30h): Execute
ETX (03h): End of Message

Check code

BCC: Block Check Code
Refer to the section 4.3 "Check code" for a BCC calculation.

Delimiter

CR (0Dh): End of packet

- 2) The monitor replies receipt result.

| Header | Message | Check code | Delimiter |
|------------------------------------|------------------------------------|------------|-----------|
| SOH-'0'-'0'-Monitor ID-'B'-'0'-'A' | STX-'C'-'B'-'0'-'A'-'0'-'1'-ST-ETX | BCC | CR |

Header

SOH (01h): Start of Header
'0' (30h): Reserved
'0' (30h): Message receiver is the controller.
Monitor ID: Indicate a replying Monitor ID.
Ex.) When this byte is set to 'A', replying monitor's ID is '1'.
'B' (42h): Message type is "Command reply".
'0'-'A' (30h,41h): Message length (10byte)

Message

STX (02h): Start of Message
'C'-'B'-'0'-'A' (43h, 42h, 30h, 41h, 30h, 31h): Auto ID Reply Command
'0'-'1' (30h, 30h): Execute
ST: Error Status
No Error : 00h (30h, 30h)
Error : 01h (30h, 31h)
ETX (03h): End of Message

Check code

BCC: Block Check Code
Refer to the section 4.3 "Check code" for a BCC calculation.

Delimiter

CR (0Dh): End of packet

17.2 Auto ID Complete

This command is used in order to notify complete status of Auto ID.

- 1) The monitor sends the controller to complete status of Auto ID.

| Header | Message | Check code | Delimiter |
|------------------------------------|--|------------|-----------|
| SOH-'0'-Monitor ID-'0'-'A'-'0'-'C' | STX-'C'-'A'-'0'-'A'-'0'-'2'-ST-MON-ETX | BCC | CR |

Header

SOH (01h): Start of Header
 '0' (30h): Reserved
 Monitor ID: Specify the Monitor ID of which you want to change a setting.
 Ex.) If Monitor ID is '1', specify 'A'.
 '0' (30h): Message sender is the controller.
 'A' (41h): Message type is "Command".
 '0'-'C' (30h,43h): Message length (12byte)

Message

STX (02h): Start of Message
 'C'-'A'-'0'-'A'-'0'-'2' (43h, 41h, 30h, 41h, 30h, 32h): Auto ID
 '0'-'2' (30h,32h): Complete
 ST: Error Status
 No Error : 00h (30h, 30h)
 Error : 01h (30h, 31h)
 MON: DETECTED MONITORS
 01h (30h, 31h) - 64h (36h, 34h)
 ETX (03h): End of Message

Check code

BCC: Block Check Code
 Refer to the section 4.3 "Check code" for a BCC calculation.

Delimiter

CR (0Dh): End of packet

- 2) The controller replies to the monitor.

| Header | Message | Check code | Delimiter |
|------------------------------------|------------------------------------|------------|-----------|
| SOH-'0'-'0'-Monitor ID-'B'-'0'-'A' | STX-'C'-'B'-'0'-'A'-'0'-'2'-ST-ETX | BCC | CR |

Header

SOH (01h): Start of Header
 '0' (30h): Reserved
 '0' (30h): Message receiver is the controller.
 Monitor ID: Indicate a replying Monitor ID.
 Ex.) When this byte is set to 'A', replying monitor's ID is '1'.
 'B' (42h): Message type is "Command reply".
 '0'-'A' (30h,41h): Message length (10byte)

Message

STX (02h): Start of Message
 'C'-'B'-'0'-'A' (43h, 42h, 30h, 41h): Auto ID Reply Command
 '0'-'2' (30h,32h): Complete
 ST : Error Status
 No Error : 00h (30h, 30h) *Fixed
 ETX (03h): End of Message

Check code

BCC: Block Check Code

Refer to the section 4.3 "Check code" for a BCC calculation.

Delimiter

CR (0Dh): End of packet

17.3 Auto ID Reset

This command is used in order to reset Auto ID.

- 1) The controller requests the monitor to reset Auto ID.

| Header | Message | Check code | Delimiter |
|------------------------------------|---------------------------------|------------|-----------|
| SOH-'0'-Monitor ID-'0'-'A'-'0'-'8' | STX-'C'-'A'-'0'-'A'-'0'-'3'-ETX | BCC | CR |

Header

SOH (01h): Start of Header
 '0' (30h): Reserved
 Monitor ID: Specify the Monitor ID of which you want to change a setting.
 Ex.) If Monitor ID is '1', specify 'A'.
 '0' (30h): Message sender is the controller.
 'A' (41h): Message type is "Command".
 '0'-'8' (30h, 38h): Message length (8byte)

Message

STX (02h): Start of Message
 'C'-'A'-'0'-'A' (43h, 41h, 30h, 41h): Auto ID Command
 '0'-'3' (30h, 33h): Reset
 ETX (03h): End of Message

Check code

BCC: Block Check Code
 Refer to the section 4.3 "Check code" for a BCC calculation.

Delimiter

CR (0Dh): End of packet

- 2) The monitor replies to the controller.

| Header | Message | Check code | Delimiter |
|------------------------------------|------------------------------------|------------|-----------|
| SOH-'0'-'0'-Monitor ID-'B'-'0'-'A' | STX-'C'-'B'-'0'-'A'-'0'-'3'-ST-ETX | BCC | CR |

Header

SOH (01h): Start of Header
 '0' (30h): Reserved
 '0' (30h): Message receiver is the controller.
 Monitor ID: Indicate a replying Monitor ID.
 Ex.) When this byte is set to 'A', replying monitor's ID is '1'.
 'B' (42h): Message type is "Command reply".
 '0'-'A' (30h,41h): Message length (10byte)

Message

STX (02h): Start of Message
 'C'-'B'-'0'-'A' (43h, 42h, 30h, 41h): Auto ID Reply
 '0'-'3' (30h, 33h): Reset
 ST: Error Status
 No Error : 00h (30h, 30h)
 Error : 01h (30h, 31h)
 ETX (03h): End of Message

Check code

BCC: Block Check Code
 Refer to the section 4.3 "Check code" for a BCC calculation.

Delimiter

CR (0Dh): End of packet

18. Input Name

18.1 Input Name Read

This command is used in order to read the setting of Input Name.

- 1) The controller requests the monitor to reply Input Name setting.

| Header | Message | Check code | Delimiter |
|------------------------------------|---------------------------------|------------|-----------|
| SOH-'0'-Monitor ID-'0'-'A'-'0'-'8' | STX-'C'-'A'-'0'-'4'-'0'-'0'-ETX | BCC | CR |

Header

SOH (01h): Start of Header
'0' (30h): Reserved
Monitor ID: Specify the Monitor ID of which you want to change a setting.
Ex.) If Monitor ID is '1', specify 'A'.
'0' (30h): Message sender is the controller.
'A' (41h): Message type is "Command".
'0'-'8' (30h, 38h): Message length (8bytes)

Message

STX (02h): Start of Message
'C'-'A'-'0'-'4' (43h, 41h, 30h, 34h): Input Name Command
'0'-'0' (30h, 30h): Read
ETX (03h): End of Message

Check code

BCC: Block Check Code
Refer to the section 4.3 "Check code" for a BCC calculation.

Delimiter

CR (0Dh): End of packet

- 2) The monitor replies Input Name to the controller.

| Header | Message | Check code | Delimiter |
|--|---|------------|-----------|
| SOH-'0'-'0'-Monitor ID-'B'-LN(H)-LN(L) | STX-'C'-'B'-'0'-'4'-'0'-'0'-Data(0)-Data(1)-Data(2)- --- -Data(n)-ETX | BCC | CR |

Header

SOH (01h): Start of Header
'0' (30h): Reserved
'0' (30h): Message receiver is the controller.
Monitor ID: Indicate a replying Monitor ID.
Ex.) When this byte is set to 'A', replying monitor's ID is '1'.
'B' (42h): Message type is "Command reply".
LN(H)-LN(L): Message length (byte length), from STX to ETX
Ex.) The byte data 20h is encoded as ASCII characters '2' and '0' (32h and 30h).

Message

STX (02h): Start of Message
'C'-'B'-'0'-'4' (43h, 42h, 30h, 34h): Input Name command reply
'0'-'0' (30h, 30h): Read
Data(n) : Input name *n = Max 14
➤ The byte data 20h is encoded as ASCII characters '2' and '0' (32h and 30h).
Ex.) For example when receiving Data(n) of 35h 36h 34h 37h 34h 31h
Step1: Input Name data is encoded as character code.
Example:
35h 36h 34h 37h 34h 31h -> '5'-'6'-'4'-'7'-'4'-'1'
Step2: Decode pairs of ASCII characters to hexadecimal values.
Example:
'5'-'6'-'4'-'7'-'4'-'1' -> 56h 47h 41h
Step3: Byte data represents the ASCII string data.

Example:
56h 47h 41h -> "VGA"
Result: Input Name is "VGA".
Note: No null termination character is sent.
ETX (03h): End of Message

Check code

BCC: Block Check Code
Refer to the section 4.3 "Check code" for a BCC calculation.

Delimiter

CR (0Dh): End of packet

18.2 Input Name Write

This command is used in order to write the setting of Input Name.

- 1) The controller requests the monitor to write Input Name.

| Header | Message | Check code | Delimiter |
|---|---|------------|-----------|
| SOH-'0'-Monitor ID-'0'-'A'- LN(H)-LN(L) | STX-'C'-'A'-'0'-'4'-'0'-'1'-Data(0)-Data(1)-Data(2)- --- -Data(n)-ETX | BCC | CR |

Header

SOH (01h): Start of Header
'0' (30h): Reserved

Monitor ID: Specify the Monitor ID of which you want to change a setting.

Ex.) If Monitor ID is '1', specify 'A'.

'0' (30h): Message sender is the controller.

'A' (41h): Message type is "Command".

LN(H)-LN(L): Message length (byte length), from STX to ETX

Ex.) The byte data 20h is encoded as ASCII characters '2' and '0' (32h and 30h).

Message

STX (02h): Start of Message

'C'-'A'-'0'-'4' (43h, 41h, 30h, 34h): Input name Command

'0'-'1' (30h, 31h): Write

Data(n) : Input name *n = Max 14

- The byte data 20h is encoded as ASCII characters '2' and '0' (32h and 30h).

Ex.) In the case of Input Name "VGA"

Step1: Input Name data is handled as character code.

Example:

"VGA" -> 56h 47h 41h (ASCII)

Step2: The hexadecimal value of each original character is encoded as two ASCII characters representing the value.

Example:

56h 47h 41h -> '5'-'6'-'4'-'7'-'4'-'1'

Result: The following data is assigned to Data(n).

35h 36h 34h 37h 34h 31h

ETX (03h): End of Message

Check code

BCC: Block Check Code

Refer to the section 4.3 "Check code" for a BCC calculation.

Delimiter

CR (0Dh): End of packet

- 2) The monitor replies a written in result.

| Header | Message | Check code | Delimiter |
|------------------------------------|------------------------------------|------------|-----------|
| SOH-'0'-'0'-Monitor ID-'B'-'0'-'A' | STX-'C'-'B'-'0'-'0'-'0'-'1'-ST-ETX | BCC | CR |

Header

SOH (01h): Start of Header

'0' (30h): Reserved

'0' (30h): Message receiver is the controller.

Monitor ID: Indicate a replying Monitor ID.

Ex.) When this byte is set to 'A', replying monitor's ID is '1'.

'B' (42h): Message type is "Command reply".

'0'-'A'(30h, 41h): Message length (10bytes)

Message

STX (02h): Start of Message

'C'-'B'-'0'-'4' (43h, 42h, 30h, 34h): Input name Command

'0'-'1' (30h, 31h): Write

ST: Status
 00h (30h, 30h): No Error
 01h (30h, 31h): Error
ETX (03h): End of Message

Check code

BCC: Block Check Code
 Refer to the section 4.3 "Check code" for a BCC calculation.

Delimiter

CR (0Dh): End of packet

18.3 Input Name Reset

This command is used in order to reset the Input Name.

- 1) The controller requests the monitor to reset Input Name.

| Header | Message | Check code | Delimiter |
|------------------------------------|---------------------------------|------------|-----------|
| SOH-'0'-Monitor ID-'0'-'A'-'0'-'8' | STX-'C'-'A'-'0'-'4'-'0'-'2'-ETX | BCC | CR |

Header

SOH (01h): Start of Header
 '0' (30h): Reserved
 Monitor ID: Specify the Monitor ID of which you want to change a setting.
 Ex.) If Monitor ID is '1', specify 'A'.
 '0' (30h): Message sender is the controller.
 'A' (41h): Message type is "Command".
 '0'-'8' (30h, 38h): Message length (8bytes)

Message

STX (02h): Start of Message
 'C'-'A'-'0'-'4' (43h, 41h, 30h, 34h): Input Name Command
 '0'-'2' (30h, 32h): Reset
 ETX (03h): End of Message

Check code

BCC: Block Check Code
 Refer to the section 4.3 "Check code" for a BCC calculation.

Delimiter

CR (0Dh): End of packet

- 2) The monitor replies result.

| Header | Message | Check code | Delimiter |
|------------------------------------|------------------------------------|------------|-----------|
| SOH-'0'-'0'-Monitor ID-'B'-'0'-'A' | STX-'C'-'B'-'0'-'0'-'0'-'2'-ST-ETX | BCC | CR |

Header

SOH (01h): Start of Header
 '0' (30h): Reserved
 '0' (30h): Message receiver is the controller.
 Monitor ID: Indicate a replying Monitor ID.
 Ex.) When this byte is set to 'A', replying monitor's ID is '1'.
 'B' (42h): Message type is "Command reply".
 '0'-'A' (30h, 41h): Message length (10bytes)

Message

STX (02h): Start of Message
 'C'-'B'-'0'-'4' (43h, 42h, 30h, 34h): Input name Command
 '0'-'2' (30h, 32h): Reset
 ST: Status
 00h (30h, 30h): No Error
 01h (30h, 31h): Error
 ETX (03h): End of Message

Check code

BCC: Block Check Code
 Refer to the section 4.3 "Check code" for a BCC calculation.

Delimiter

CR (0Dh): End of packet

19. Power Save Mode

19.1 Power Save Mode Read

This command is used in order to read the Power Save Mode.

- 1) The controller requests the monitor to read Power Save Mode

| Header | Message | Check code | Delimiter |
|------------------------------------|---------------------------------|------------|-----------|
| SOH-'0'-Monitor ID-'0'-'A'-'0'-'8' | STX-'C'-'A'-'0'-'B'-'0'-'0'-ETX | BCC | CR |

Header

SOH (01h): Start of Header
'0' (30h): Reserved
Monitor ID: Specify the Monitor ID of which you want to change a setting.
Ex.) If Monitor ID is '1', specify 'A'.
'0' (30h): Message sender is the controller.
'A' (41h): Message type is "Command".
'0'-'8' (30h,38h): Message length (8byte)

Message

STX (02h): Start of Message
'C'-'A'-'0'-'B' (43h, 41h, 30h, 42h): Power Save Mode command
'0'-'0' (30h, 30h): Read
ETX (03h): End of Message

Check code

BCC: Block Check Code
Refer to the section 4.3 "Check code" for a BCC calculation.

Delimiter

CR (0Dh): End of packet

- 2) The monitor replies Power Save Mode to the controller.

| Header | Message | Check code | Delimiter |
|------------------------------------|--------------------------------------|------------|-----------|
| SOH-'0'-'0'-Monitor ID-'B'-'0'-'A' | STX-'C'-'B'-'0'-'B'-'0'-'0'-MODE-ETX | BCC | CR |

Header

SOH (01h): Start of Header
'0' (30h): Reserved
'0' (30h): Message receiver is the controller.
Monitor ID: Indicate a replying Monitor ID.
Ex.) When this byte is set to 'A', replying monitor's ID is '1'.
'B' (42h): Message type is "Command reply".
'0'-'A' (30h,41h): Message length (10byte)

Message

STX (02h): Start of Message
'C'-'B'-'0'-'B' (43h, 42h, 30h, 42h): Power Save Mode Reply
'0'-'0' (30h, 30h): Read
MODE: POWER SAVE MODE
00h (30h, 30h): AUTO POWER SAVE
01h (30h, 31h): AUTO STANDBY
02h (30h, 32h): POWER SAVE OFF
ETX (03h): End of Message

Check code

BCC: Block Check Code
Refer to the section 4.3 "Check code" for a BCC calculation.

Delimiter

CR (0Dh): End of packet

19.2 Power Save Mode Write

This command is used in order to write the setting of Power Save Mode.

- 1) The controller requests the monitor to write Power Save Mode.

| Header | Message | Check code | Delimiter |
|------------------------------------|--------------------------------------|------------|-----------|
| SOH-'0'-Monitor ID-'0'-'A'-'0'-'A' | STX-'C'-'A'-'0'-'B'-'0'-'1'-MODE-ETX | BCC | CR |

Header

SOH (01h): Start of Header
 '0' (30h): Reserved
 Monitor ID: Specify the Monitor ID of which you want to change a setting.
 Ex.) If Monitor ID is '1', specify 'A'.
 '0' (30h): Message sender is the controller.
 'A' (41h): Message type is "Command".
 '0'-'A' (30h, 41h): Message length (10byte)

Message

STX (02h): Start of Message
 'C'-'A'-'0'-'B' (43h, 41h, 30h, 42h): Power Save Mode command
 '0'-'1' (30h, 31h): Write
 MODE: POWER SAVE MODE
 00h (30h, 30h): AUTO POWER SAVE
 01h (30h, 31h): AUTO STANDBY
 02h (30h, 32h): POWER SAVE OFF
 ETX (03h): End of Message

Check code

BCC: Block Check Code
 Refer to the section 4.3 "Check code" for a BCC calculation.

Delimiter

CR (0Dh): End of packet

- 2) The monitor replies a written in result.

| Header | Message | Check code | Delimiter |
|------------------------------------|------------------------------------|------------|-----------|
| SOH-'0'-'0'-Monitor ID-'B'-'0'-'A' | STX-'C'-'B'-'0'-'B'-'0'-'1'-ST-ETX | BCC | CR |

Header

SOH (01h): Start of Header
 '0' (30h): Reserved
 '0' (30h): Message receiver is the controller.
 Monitor ID: Indicate a replying Monitor ID.
 Ex.) When this byte is set to 'A', replying monitor's ID is '1'.
 'B' (42h): Message type is "Command reply".
 '0'-'A' (30h,41h): Message length (10byte)

Message

STX (02h): Start of Message
 'C'-'B'-'0'-'B' (43h, 42h, 30h, 42h): Power Save Mode Reply
 '0'-'1' (30h, 31h): Write
 ST: Error Status
 No Error : 00h (30h, 30h)
 Error : 01h (30h, 31h)
 ETX (03h): End of Message

Check code

BCC: Block Check Code
 Refer to the section 4.3 "Check code" for a BCC calculation.

Delimiter

CR (0Dh): End of packet

19.3 Auto Power Save Time Read

This command is used in order to read the setting of Auto Power Save Time.

- 1) The controller requests the monitor to reply Time setting.

| Header | Message | Check code | Delimiter |
|------------------------------------|---------------------------------|------------|-----------|
| SOH-'0'-Monitor ID-'0'-'A'-'0'-'8' | STX-'C'-'A'-'0'-'B'-'0'-'2'-ETX | BCC | CR |

Header

SOH (01h): Start of Header
 '0' (30h): Reserved
 Monitor ID: Specify the Monitor ID of which you want to change a setting.
 Ex.) If Monitor ID is '1', specify 'A'.
 '0' (30h): Message sender is the controller.
 'A' (41h): Message type is "Command".
 '0'-'8' (30h,38h): Message length (8byte)

Message

STX (02h): Start of Message
 'C'-'A'-'0'-'B' (43h, 41h, 30h, 42h): Power Save Mode command
 '0'-'2' (30h, 30h): Auto Power Save Read
 ETX (03h): End of Message

Check code

BCC: Block Check Code
 Refer to the section 4.3 "Check code" for a BCC calculation.

Delimiter

CR (0Dh): End of packet

- 2) The monitor replies Time to the controller.

| Header | Message | Check code | Delimiter |
|------------------------------------|--------------------------------------|------------|-----------|
| SOH-'0'-'0'-Monitor ID-'B'-'0'-'A' | STX-'C'-'B'-'0'-'B'-'0'-'2'-TIME-ETX | BCC | CR |

Header

SOH (01h): Start of Header
 '0' (30h): Reserved
 '0' (30h): Message receiver is the controller.
 Monitor ID: Indicate a replying Monitor ID.
 Ex.) When this byte is set to 'A', replying monitor's ID is '1'.
 'B' (42h): Message type is "Command reply".
 '0'-'A' (30h,41h): Message length (10byte)

Message

STX (02h): Start of Message
 'C'-'B'-'0'-'B' (43h, 42h, 30h, 42h): Power Save Mode Reply
 '0'-'2' (30h, 32h): Auto Power Save Time Read
 TIME: AUTO POWER SAVE TIME (sec.)
 00h (30h, 30h) - 78h (37h, 38h): 1 (5dec.) - 120 (600sec.)
 ETX (03h): End of Message

Check code

BCC: Block Check Code
 Refer to the section 4.3 "Check code" for a BCC calculation.

Delimiter

CR (0Dh): End of packet

19.4 Auto Power Save Time Write

This command is used in order to write the setting of Auto Power Save Time.

- 1) The controller requests the monitor to write Time.

| Header | Message | Check code | Delimiter |
|------------------------------------|--------------------------------------|------------|-----------|
| SOH-'0'-Monitor ID-'0'-'A'-'0'-'A' | STX-'C'-'A'-'0'-'B'-'0'-'3'-TIME-ETX | BCC | CR |

Header

SOH (01h): Start of Header
 '0' (30h): Reserved
 Monitor ID: Specify the Monitor ID of which you want to change a setting.
 Ex.) If Monitor ID is '1', specify 'A'.
 '0' (30h): Message sender is the controller.
 'A' (41h): Message type is "Command".
 '0'-'A' (30h,41h): Message length (10byte)

Message

STX (02h): Start of Message
 'C'-'A'-'0'-'B' (43h, 41h, 30h, 42h): Power Save Mode command
 '0'-'3' (30h, 33h): Auto Power Save Time Write
 TIME: AUTO POWER SAVE TIME (sec.)
 00h (30h, 30h) - 78h (37h, 38h): 1 (5dec.) - 120 (600sec.)
 ETX (03h): End of Message

Check code

BCC: Block Check Code
 Refer to the section 4.3 "Check code" for a BCC calculation.

Delimiter

CR (0Dh): End of packet

- 2) The monitor replies a written in result.

| Header | Message | Check code | Delimiter |
|------------------------------------|------------------------------------|------------|-----------|
| SOH-'0'-'0'-Monitor ID-'B'-'0'-'8' | STX-'C'-'B'-'0'-'B'-'0'-'3'-ST-ETX | BCC | CR |

Header

SOH (01h): Start of Header
 '0' (30h): Reserved
 '0' (30h): Message receiver is the controller.
 Monitor ID: Indicate a replying Monitor ID.
 Ex.) When this byte is set to 'A', replying monitor's ID is '1'.
 'B' (42h): Message type is "Command reply".
 '0'-'8' (30h,38h): Message length (8byte)

Message

STX (02h): Start of Message
 'C'-'B'-'0'-'B' (43h, 42h, 30h, 42h): Power Save Mode Reply
 '0'-'3' (30h, 33h): Auto Power Save Time Write
 ST: Error Status
 No Error : 00h (30h, 30h)
 Error : 01h (30h, 31h)
 ETX (03h): End of Message

Check code

BCC: Block Check Code
 Refer to the section 4.3 "Check code" for a BCC calculation.

Delimiter

CR (0Dh): End of packet

19.5 Auto Standby Time Read

This command is used in order to read the setting of Auto Standby Time.

- 1) The controller requests the monitor to reply Time setting.

| Header | Message | Check code | Delimiter |
|------------------------------------|---------------------------------|------------|-----------|
| SOH-'0'-Monitor ID-'0'-'A'-'0'-'8' | STX-'C'-'A'-'0'-'B'-'0'-'4'-ETX | BCC | CR |

Header

SOH (01h): Start of Header
 '0' (30h): Reserved
 Monitor ID: Specify the Monitor ID of which you want to change a setting.
 Ex.) If Monitor ID is '1', specify 'A'.
 '0' (30h): Message sender is the controller.
 'A' (41h): Message type is "Command".
 '0'-'8' (30h,38h): Message length (8byte)

Message

STX (02h): Start of Message
 'C'-'A'-'0'-'B' (43h, 41h, 30h, 42h): Power Save Mode command
 '0'-'4' (30h, 30h): Auto Standby Time Read
 ETX (03h): End of Message

Check code

BCC: Block Check Code
 Refer to the section 4.3 "Check code" for a BCC calculation.

Delimiter

CR (0Dh): End of packet

- 2) The monitor replies Time to the controller.

| Header | Message | Check code | Delimiter |
|------------------------------------|--------------------------------------|------------|-----------|
| SOH-'0'-'0'-Monitor ID-'B'-'0'-'A' | STX-'C'-'B'-'0'-'B'-'0'-'4'-TIME-ETX | BCC | CR |

Header

SOH (01h): Start of Header
 '0' (30h): Reserved
 '0' (30h): Message receiver is the controller.
 Monitor ID: Indicate a replying Monitor ID.
 Ex.) When this byte is set to 'A', replying monitor's ID is '1'.
 'B' (42h): Message type is "Command reply".
 '0'-'A' (30h,41h): Message length (10byte)

Message

STX (02h): Start of Message
 'C'-'B'-'0'-'B' (43h, 42h, 30h, 42h): Power Save Mode Reply
 '0'-'4' (30h, 34h): Auto Standby Time Read
 TIME: AUTO STANDBY TIME (sec.)
 00h (30h, 30h) - 78h (37h, 38h): 1 (5dec.) - 120 (600sec.)
 ETX (03h): End of Message

Check code

BCC: Block Check Code
 Refer to the section 4.3 "Check code" for a BCC calculation.

Delimiter

CR (0Dh): End of packet

19.6 Auto Standby Time Write

This command is used in order to write the setting of Auto Standby Time.

- 1) The controller requests the monitor to write Time.

| Header | Message | Check code | Delimiter |
|--|--------------------------------------|------------|-----------|
| SOH-'0'-Monitor ID-'0'- 'A'-'0'-'A' | STX-'C'-'A'-'0'-'B'-'0'-'5'-TIME-ETX | BCC | CR |

Header

SOH (01h): Start of Header
 '0' (30h): Reserved
 Monitor ID: Specify the Monitor ID of which you want to change a setting.
 Ex.) If Monitor ID is '1', specify 'A'.
 '0' (30h): Message sender is the controller.
 'A' (41h): Message type is "Command".
 '0'-'A' (30h,41h): Message length (10byte)

Message

STX (02h): Start of Message
 'C'-'A'-'0'-'B' (43h, 41h, 30h, 42h): Power Save Mode command
 '0'-'5' (30h, 35h): Auto Standby Time Write
 TIME: AUTO STANDBY TIME (sec.)
 00h (30h, 30h) - 78h (37h, 38h): 1 (5dec.) - 120 (600sec.)
 ETX (03h): End of Message

Check code

BCC: Block Check Code
 Refer to the section 4.3 "Check code" for a BCC calculation.

Delimiter

CR (0Dh): End of packet

- 2) The monitor replies a written in result.

| Header | Message | Check code | Delimiter |
|--|------------------------------------|------------|-----------|
| SOH-'0'-'0'-Monitor ID- 'B'-'0'-'A' | STX-'C'-'B'-'0'-'B'-'0'-'5'-ST-ETX | BCC | CR |

Header

SOH (01h): Start of Header
 '0' (30h): Reserved
 '0' (30h): Message receiver is the controller.
 Monitor ID: Indicate a replying Monitor ID.
 Ex.) When this byte is set to 'A', replying monitor's ID is '1'.
 'B' (42h): Message type is "Command reply".
 '0'-'A' (30h,41h): Message length (10byte)

Message

STX (02h): Start of Message
 'C'-'B'-'0'-'B' (43h, 42h, 30h, 42h): Power Save Mode Reply
 '0'-'5' (30h, 35h): Auto Standby Time Write
 ST: Error Status
 No Error : 00h (30h, 30h)
 Error : 01h (30h, 31h)
 ETX (03h): End of Message

Check code

BCC: Block Check Code
 Refer to the section 4.3 "Check code" for a BCC calculation.

Delimiter

CR (0Dh): End of packet

20. Setting Copy

20.1 Setting Copy Read

This command is used in order to read the Setting Copy.

- 1) The controller requests the monitor to read Setting Copy

| Header | Message | Check code | Delimiter |
|------------------------------------|---------------------------------|------------|-----------|
| SOH-'0'-Monitor ID-'0'-'A'-'0'-'8' | STX-'C'-'A'-'0'-'9'-'0'-'0'-ETX | BCC | CR |

Header

SOH (01h): Start of Header
'0' (30h): Reserved
Monitor ID: Specify the Monitor ID of which you want to change a setting.
Ex.) If Monitor ID is '1', specify 'A'.
'0' (30h): Message sender is the controller.
'A' (41h): Message type is "Command".
'0'-'8'(30h, 38h): Message length (8byte)

Message

STX (02h): Start of Message
'C'-'A'-'0'-'9' (43h,41h,30h,39h): Setting Copy command
'0'-'0' (30h,30h): Target Read
ETX (03h): End of Message

Check code

BCC: Block Check Code
Refer to the section 4.3 "Check code" for a BCC calculation.

Delimiter

CR (0Dh): End of packet

- 2) The monitor replies Setting Copy to the controller.

| Header | Message | Check code | Delimiter |
|------------------------------------|---|------------|-----------|
| SOH-'0'-'0'-Monitor ID-'B'-'1'-'0' | STX-'C'-'B'-'0'-'9'-'0'-'0'-T4-T3-T2-T1-ETX | BCC | CR |

Header

SOH (01h): Start of Header
'0' (30h): Reserved
'0' (30h): Message receiver is the controller.
Monitor ID: Indicate a replying Monitor ID.
Ex.) When this byte is set to 'A', replying monitor's ID is '1'.
'B' (42h): Message type is "Command reply".
'1'-'0'(31h,30h): Message length (16byte)

Message

STX (02h): Start of Message
'C'-'B'-'0'-'9' (43h, 42h, 30h, 39h): Setting Copy Reply
'0'-'0' (30h, 30h): Target Read
T1 - T4 : 00h (30h, 30h) - FFh (46h, 46h)
T1 : Setting Copy Target 4 (Bit12-Bit15)
T2 : Setting Copy Target 3 (Bit8-Bit11)
T3 : Setting Copy Target 2 (Bit4-Bit7)
T4 : Setting Copy Target 1 (Bit0-Bit3)
Bit0: ALL INPUT
Bit1: PICTURE
Bit2: ADJUST
Bit3: AUDIO
Bit4: SCHEDULE
Bit5: MP-CTRL

Bit6: OSD
Bit7: MULTI DISP
Bit8: PROTECT
Bit9: EXT-CTRL
Bit10: ADVANCED
Bit11: ADVANCED2
Bit12: HTTP
Bit13: Reserve
Bit14: Reserve
Bit15: Reserve

Ex.) Setting the following value for T4

Bit0: ALL INPUT is OFF (0).

Bit1: PICTURE is OFF (0).

Bit2: ADJUST is ON (1).

Bit3: AUDIO is ON (1).

Step 1: Put above bit in following order.

Bit3-Bit2-Bit1-Bit0

Value: 1100

Step 2: Write the value of Step 1 by a hexadecimal number.

Value: 0Ch

Step 3: Encode the value of Step 2 to ASCII characters.

Value: '0' and 'C' (30h and 43h)

ETX (03h): End of Message

Check code

BCC: Block Check Code

Refer to the section 4.3 "Check code" for a BCC calculation.

Delimiter

CR (0Dh): End of packet

20.2 Setting Copy Write

This command is used in order to write the setting of Setting Copy.

- 1) The controller requests the monitor to write Setting Copy.

| Header | Message | Check code | Delimiter |
|------------------------------------|---|------------|-----------|
| SOH-'0'-Monitor ID-'0'-'A'-'1'-'0' | STX-'C'-'A'-'0'-'9'-'0'-'1'-T4-T3-T2-T1-ETX | BCC | CR |

Header

SOH (01h): Start of Header
 '0' (30h): Reserved
 Monitor ID: Specify the Monitor ID of which you want to change a setting.
 Ex.) If Monitor ID is '1', specify 'A'.
 '0' (30h): Message sender is the controller.
 'A' (41h): Message type is "Command".
 '1'-'0' (31h,30h): Message length

Message

STX (02h): Start of Message
 'C'-'A'-'0'-'9' (43h,41h,30h,39h): Setting Copy command
 '0'-'1' (30h,31h): Target Write
 T1 - T4 : 00h (30h, 30h) - FFh (46h, 46h)
 T1 : Setting Copy Target 4 (Bit12-Bit15)
 T2 : Setting Copy Target 3 (Bit8-Bit11)
 T3 : Setting Copy Target 2 (Bit4-Bit7)
 T4 : Setting Copy Target 1 (Bit0-Bit3)
 Bit0: ALL INPUT
 Bit1: PICTURE
 Bit2: ADJUST
 Bit3: AUDIO
 Bit4: SCHEDULE
 Bit5: MP-CTRL
 Bit6: OSD
 Bit7: MULTI DISP
 Bit8: PROTECT
 Bit9: EXT-CTRL
 Bit10: ADVANCED
 Bit11: ADVANCED2
 Bit12: HTTP
 Bit13: Reserve
 Bit14: Reserve
 Bit15: Reserve
 Ex.) Setting the following value for T4
 Bit0: ALL INPUT is OFF (0).
 Bit1: PICTURE is OFF (0).
 Bit2: ADJUST is ON (1).
 Bit3: AUDIO is ON (1).
 Step 1: Put above bit in following order.
 Bit3-Bit2-Bit1-Bit0
 Value: 1100
 Step 2: Write the value of Step 1 by a hexadecimal number.
 Value: 0Ch
 Step 3: Encode the value of Step 2 to ASCII characters.
 Value: '0' and 'C' (30h and 43h)
 ETX (03h): End of Message

Check code

BCC: Block Check Code
 Refer to the section 4.3 "Check code" for a BCC calculation.

Delimiter

CR (0Dh): End of packet

2) The monitor replies a written in result.

| Header | Message | Check code | Delimiter |
|--|------------------------------------|------------|-----------|
| SOH-'0'-'0'-Monitor ID- 'B'-'0'-'A' | STX-'C'-'B'-'0'-'9'-'0'-'1'-ST-ETX | BCC | CR |

Header

SOH (01h): Start of Header
 '0' (30h): Reserved
 '0' (30h): Message receiver is the controller.
 Monitor ID: Indicate a replying Monitor ID.
 Ex.) When this byte is set to 'A', replying monitor's ID is '1'.
 'B' (42h): Message type is "Command reply".
 '0'-'A' (30h,41h): Message length (10byte)

Message

STX (02h): Start of Message
 'C'-'B'-'0'-'9' (43h, 42h, 30h, 39h): Setting Copy Reply
 '0'-'1' (30h, 30h): Target Write
 ST: Status
 No Error : 00h (30h, 30h)
 Error : 01h (30h, 31h)
 ETX (03h): End of Message

Check code

BCC: Block Check Code
 Refer to the section 4.3 "Check code" for a BCC calculation.

Delimiter

CR (0Dh): End of packet

20.3 Setting Copy Start

This command is used in order to start Setting Copy.

- 1) The controller requests the monitor to write Setting Copy Start.

| Header | Message | Check code | Delimiter |
|------------------------------------|---------------------------------|------------|-----------|
| SOH-'0'-Monitor ID-'0'-'A'-'0'-'8' | STX-'C'-'A'-'0'-'9'-'0'-'2'-ETX | BCC | CR |

Header

SOH (01h): Start of Header
 '0' (30h): Reserved
 Monitor ID: Specify the Monitor ID of which you want to change a setting.
 Ex.) If Monitor ID is '1', specify 'A'.
 '0' (30h): Message sender is the controller.
 'A' (41h): Message type is "Command".
 '0'-'8'(30h, 38h): Message length (8byte)

Message

STX (02h): Start of Message
 'C'-'A'-'0'-'9' (43h,41h,30h,39h): Setting Copy command
 '0'-'2' (30h,32h): Start
 ETX (03h): End of Message

Check code

BCC: Block Check Code
 Refer to the section 4.3 "Check code" for a BCC calculation.

Delimiter

CR (0Dh): End of packet

- 2) The monitor replies to the controller.

| Header | Message | Check code | Delimiter |
|------------------------------------|------------------------------------|------------|-----------|
| SOH-'0'-'0'-Monitor ID-'B'-'0'-'A' | STX-'C'-'B'-'0'-'9'-'0'-'2'-ST-ETX | BCC | CR |

Header

SOH (01h): Start of Header
 '0' (30h): Reserved
 '0' (30h): Message receiver is the controller.
 Monitor ID: Indicate a replying Monitor ID.
 Ex.) When this byte is set to 'A', replying monitor's ID is '1'.
 'B' (42h): Message type is "Command reply".
 '0'-'A'(30h,41h): Message length (10byte)

Message

STX (02h): Start of Message
 'C'-'B'-'0'-'9' (43h, 42h, 30h, 39h): Setting Copy Reply
 '0'-'2' (30h, 30h): Start
 ST: Status
 No Error : 00h (30h, 30h)
 Error : 01h (30h, 31h)
 ETX (03h): End of Message

Check code

BCC: Block Check Code
 Refer to the section 4.3 "Check code" for a BCC calculation.

Delimiter

CR (0Dh): End of packet

21. Security Enable

21.1 Security Enable Read

This command is used in order to read the Security Enable.

- 1) The controller requests the monitor to read Security Enable

| Header | Message | Check code | Delimiter |
|------------------------------------|---------------------------------|------------|-----------|
| SOH-'0'-Monitor ID-'0'-'A'-'0'-'8' | STX-'C'-'A'-'0'-'C'-'0'-'2'-ETX | BCC | CR |

Header

SOH (01h): Start of Header
'0' (30h): Reserved
Monitor ID: Specify the Monitor ID of which you want to change a setting.
Ex.) If Monitor ID is '1', specify 'A'.
'0' (30h): Message sender is the controller.
'A' (41h): Message type is "Command".
'0'-'8' (30h, 38h): Message length (8byte)

Message

STX (02h): Start of Message
'C'-'A'-'0'-'C' (43h, 41h, 30h, 43h): Security password Command
'0'-'2' (30h, 32h): Enable Read
ETX (03h): End of Message

Check code

BCC: Block Check Code
Refer to the section 4.3 "Check code" for a BCC calculation.

Delimiter

CR (0Dh): End of packet

- 2) The monitor replies Security Enable to the controller.

| Header | Message | Check code | Delimiter |
|------------------------------------|------------------------------------|------------|-----------|
| SOH-'0'-'0'-Monitor ID-'B'-'0'-'A' | STX-'C'-'B'-'0'-'C'-'0'-'2'-EN-ETX | BCC | CR |

Header

SOH (01h): Start of Header
'0' (30h): Reserved
'0' (30h): Message receiver is the controller.
Monitor ID: Indicate a replying Monitor ID.
Ex.) When this byte is set to 'A', replying monitor's ID is '1'.
'B' (42h): Message type is "Command reply".
'0'-'A' (30h,41h): Message length (10byte)

Message

STX (02h): Start of Message
'C'-'B'-'0'-'C'-'0'-'2' (43h, 42h, 30h, 41h, 30h, 32h): Get Security Enable Disable Reply
EN: SECURE MODE
00h (30h, 30h): OFF
01h (30h, 31h): START-UP LOCK
02h (30h, 32h): CONTROL LOCK
03h (30h, 33h): BOTH LOCK
ETX (03h): End of Message

Check code

BCC: Block Check Code

Refer to the section 4.3 "Check code" for a BCC calculation.

Delimiter

CR (0Dh): End of packet

21.2 Security Enable Write

This command is used in order to write the setting of Security Enable.

- 1) The controller requests the monitor to set Security password.

| Header | Message | Check code | Delimiter |
|------------------------------------|---|------------|-----------|
| SOH-'0'-Monitor ID-'0'-'A'-'1'-'C' | STX-'C'-'A'-'0'-'C'-'0'-'1'-EN-'0'-'0'-PWD1-...-PWD16-ETX | BCC | CR |

Header

SOH (01h): Start of Header
 '0' (30h): Reserved
 Monitor ID: Specify the Monitor ID of which you want to change a setting.
 Ex.) If Monitor ID is '1', specify 'A'.
 '0' (30h): Message sender is the controller.
 'A' (41h): Message type is "Command".
 '1'-'C' (31h,43h): Message length (28byte)

Message

STX (02h): Start of Message
 'C'-'A'-'0'-'C' (43h, 41h, 30h, 43h): Security Password Command
 '0'-'1' (30h, 31h): Enable Write
 EN: SECURE MODE
 00h (30h, 30h): OFF
 01h (30h, 31h): START-UP LOCK
 02h (30h, 32h): CONTROL LOCK
 03h (30h, 33h): BOTH LOCK
 '0'-'0' (30h, 30h): Reserved
 PWD1 - PWD16: Password data
 ➤ The password data is encoded as the following procedure.
 Ex.) In the case of password data "1234"
 Step1: Password data is handled as character code.
 Example:
 "1234" -> 31h 32h 33h 34h (ASCII)
 Step2: The hexadecimal value of each original character is encoded as two ASCII characters representing the hex value.
 Example:
 31h 32h 33h 34h -> '3'-'1'-'3'-'2'-'3'-'3'-'3'-'4'
 Step3: Password data is handled as character code once again.
 Example:
 '3'-'1'-'3'-'2'-'3'-'3'-'3'-'4' -> 33h 31h 33h 32h 33h 33h 33h 34h (ASCII)
 Step4: The hexadecimal value of each original character is encoded as two ASCII characters representing the value.
 Example:
 33h 31h 33h 32h 33h 33h 33h 34h
 -> '3'-'3'-'3'-'1'-'3'-'3'-'3'-'2'-'3'-'3'-'3'-'3'-'3'-'3'-'4'
 Result: The following data is assigned to PWD1-PWD16.
 33h 33h 33h 31h 33h 33h 33h 32h 33h 33h 33h 33h 33h 33h 33h 34h
 ETX (03h): End of Message

Check code

BCC: Block Check Code
 Refer to the section 4.3 "Check code" for a BCC calculation.

Delimiter

CR (0Dh): End of packet

- 2) The monitor replies a written in result.

| Header | Message | Check code | Delimiter |
|------------------------------------|------------------------------------|------------|-----------|
| SOH-'0'-'0'-Monitor ID-'B'-'0'-'A' | STX-'C'-'B'-'0'-'C'-'0'-'1'-ST-ETX | BCC | CR |

Header

SOH (01h): Start of Header
'0' (30h): Reserved
'0' (30h): Message receiver is the controller.
Monitor ID: Indicate a replying Monitor ID.
 Ex.) When this byte is set to 'A', replying monitor's ID is '1'.
'B' (42h): Message type is "Command reply".
'0'-'A' (30h,41h): Message length (10byte)

Message

STX (02h): Start of Message
'C'-'B'-'0'-'C' (43h, 42h, 30h, 43h): Security password Reply Command
'0'-'1' (30h, 31h): Enable Write
ST: Error Status
 00h: No Error
 01h: Error
ETX (03h): End of Message

Check code

BCC: Block Check Code
 Refer to the section 4.3 "Check code" for a BCC calculation.

Delimiter

CR (0Dh): End of packet

22. LAN MAC Address

22.1 LAN MAC Address Read

This command is used in order to read the MAC Address.

- 1) The controller requests the monitor to read MAC Address

| Header | Message | Check code | Delimiter |
|------------------------------------|---------------------------------|------------|-----------|
| SOH-'0'-Monitor ID-'0'-'A'-'0'-'8' | STX-'C'-'2'-'2'-'A'-'0'-'2'-ETX | BCC | CR |

Header

SOH (01h) : Start of Header
'0' (30h) : Reserved
Monitor ID : Specify the Monitor ID from which you want to get status.
Ex.) If Monitor ID is '1', specify 'A'.
'0' (30h) : Message sender is the controller.
'A' (41h) : Message Type is "Command".
'0'-'8' (30h, 38h) : Message length is 8 bytes.

Message

STX (02h): Start of Message
'C'-'2'-'2'-'A': LAN read command.
'0'-'2': MAC Address
ETX (03h): End of Message

Check code

BCC: Block Check Code
Refer to the section 4.3 "Check code" for a BCC calculation.

Delimiter

CR (0Dh): End of packet

- 2) The monitor replies MAC Address to the controller.

| Header | Message | Check code | Delimiter |
|--|--|------------|-----------|
| SOH-'0'-'0'-Monitor ID-'B'-LN(H)-LN(L) | STX-'C'-'3'-'2'-'A'-RC-'0'-'2'-IPV-MAC(0)-...-MAC(n)-ETX | BCC | CR |

Header

SOH (01h): Start of Header
'0' (30h): Reserved
'0' (30h): Message receiver is the controller.
Monitor ID: Indicate a replying Monitor ID.
Ex.) When this byte is set to 'A', the replying Monitor ID is '1'.
'B' (42h): Message Type is "Command reply".
LN(H)-LN(L): Message length (byte length), from STX to ETX

Message

STX(02h):Start of Message
'C'-'3'-'2'-'A': LAN read reply command.
RC: Reply result Code
'0'-'0' (30h, 30h): Normal
'F'-'F' (46h, 46h): Abnormal
'0'-'2': MAC Address
IPV: IPv4 or IPv6
'0'-'4' (30h, 34h): IPv4
'0'-'6' (30h, 36h): IPv6
MAC(0-n): MAC Address
In the case of IPv4 -> n = 4

In the case of IPv6 -> n = 7
ETX (03h): End of Message

Check code

BCC: Block Check Code

Refer to the section 4.3 "Check code" for a BCC calculation.

Delimiter

CR (0Dh): End of packet

23. Proof of Play

23.1 Set Proof of Play Operation Mode

This command is used in order to set Operation mode of Proof of Play.

- 1) The controller requests the monitor to set Operation mode of Proof of Play.

| Header | Message | Check code | Delimiter |
|------------------------------------|------------------------------------|------------|-----------|
| SOH-'0'-Monitor ID-'0'-'A'-'0'-'A' | STX-'C'-'A'-'1'-'5'-'0'-'0'-MD-ETX | BCC | CR |

Header

SOH (01h) : Start of Header
'0' (30h) : Reserved
Monitor ID : Specify the Monitor ID from which you want to get status.
Ex.) If Monitor ID is '1', specify 'A'.
'0' (30h) : Message sender is the controller.
'A' (41h) : Message Type is "Command".
'0'-'A' (30h, 41h) : Message length is 10 bytes.

Message

STX (02h): Start of Message
'C'-'A'-'1'-'5': Proof of Play command
'0'-'0' (30h,30h): Set Proof of Play Operation Mode command
MD : Mode of Proof of Play.
'0'-'0' (30h, 30h): Stop
'0'-'1' (30h, 31h): Start
'0'-'2' (30h, 32h): Clear Log data
ETX (03h): End of Message

Check code

BCC: Block Check Code
Refer to the section 4.3 "Check code" for a BCC calculation.

Delimiter

CR (0Dh): End of packet

- 2) The monitor replies the result of set Operation mode to the controller.

| Header | Message | Check code | Delimiter |
|------------------------------------|------------------------------------|------------|-----------|
| SOH-'0'-Monitor ID-'0'-'B'-'0'-'A' | STX-'C'-'B'-'1'-'5'-'0'-'0'-ST-ETX | BCC | CR |

Header

SOH (01h) : Start of Header
'0' (30h) : Reserved
Monitor ID : Specify the Monitor ID from which you want to get status.
Ex.) If Monitor ID is '1', specify 'A'.
'0' (30h) : Message sender is the controller.
'A' (41h) : Message Type is "Command".
'0'-'A' (30h, 41h) : Message length is 10 bytes.

Message

STX (02h): Start of Message
'C'-'B'-'1'-'5': Proof of Play reply command
'0'-'0' (30h,30h): Set Proof of Play Operation Mode command
ST: Status
'0'-'0' (30h, 30h): No Error
'0'-'1' (30h, 31h): Error
'0'-'2' (30h, 32h): Already Start/Stop/Clear

ETX (03h): End of Message

Check code

BCC: Block Check Code

Refer to the section 4.3 "Check code" for a BCC calculation.

Delimiter

CR (0Dh): End of packet

23.2 Get Proof of Play Current

This command is used in order to get Current log data of Proof of Play.

Note : Proof of Play information cannot be read from the display when it is in OFF state. The display must be fully powered on to read Proof of Play information. Also the display does not continue to create any new logs while it is in OFF state.

- 1) The controller requests the monitor to get Current log data of Proof of Play.

| Header | Message | Check code | Delimiter |
|------------------------------------|---------------------------------|------------|-----------|
| SOH-'0'-Monitor ID-'0'-'A'-'0'-'8' | STX-'C'-'A'-'1'-'5'-'0'-'1'-ETX | BCC | CR |

Header

SOH (01h) : Start of Header
 '0' (30h) : Reserved
 Monitor ID : Specify the Monitor ID from which you want to get status.
 Ex.) If Monitor ID is '1', specify 'A'.
 '0' (30h) : Message sender is the controller.
 'A' (41h) : Message Type is "Command".
 '0'-'8' (30h, 38h) : Message length is 8 bytes.

Message

STX (02h) : Start of Message
 'C'-'A'-'1'-'5': Proof of Play command
 '0'-'1' (30h,31h) : Get Current log of Proof of Play command
 ETX (03h) : End of Message

Check code

BCC: Block Check Code
 Refer to the section 4.3 "Check code" for a BCC calculation.

Delimiter

CR (0Dh) : End of packet

- 2) The monitor replies the result of Current log data to the controller.

| Header | Message | Check code | Delimiter |
|------------------------------------|---|------------|-----------|
| SOH-'0'-Monitor ID-'0'-'B'-'3'-'4' | STX-'C'-'B'-'1'-'5'-'0'-'1'-ST-CNH-CNL-Data(0)-Data(1)-Data(2)---Data(18)-ETX | BCC | CR |

Header

SOH (01h) : Start of Header
 '0' (30h) : Reserved
 Monitor ID : Specify the Monitor ID from which you want to get status.
 Ex.) If Monitor ID is '1', specify 'A'.
 '0' (30h) : Message sender is the controller.
 'A' (41h) : Message Type is "Command".
 '3'-'4' (33h, 34h) : Message length is 52 bytes.

Message

STX (02h) : Start of Message
 'C'-'B'-'1'-'5': Proof of Play reply command
 '0'-'1' (30h,31h) : Get Current log of Proof of Play command
 ST: Status
 No Error : 00h (30h, 30h)
 Error: 01h (30h, 31h)
 CNH: Current log data Number (High byte)

CNL: Current log data Number (Low byte)
'0','0','0','1'-'F','F','F','F' (30h, 30h, 30h, 31h - 46h, 46h, 46h, 46h) :1 - 65535
Data(0)-Data(18): Data of Proof of Play

※Log Data of Proof of Play : Data(0)-Data(18)

Data(0): Check INPUT PICTURE

※Same as VCP(Page11 06H Input source) reply parameter.

Refer to Item "INPUT" on page 41.

Data(1)-Data(4) : Check Input Signal

'0'-'0'-'0'-'0'-'0'-'0'-'0'-'0' (30h,30h,30h,30h,30h,30h,30h,30h):No signal

'F'-'F'-'F'-'F'-'F'-'F'-'F'-'F' (46h,46h,46h,46h,46h,46h,46h,46h):Invalid signal

'*'-'*'-'*'-'*'-'*'-'*'-'*'-'*' (**h,**h,**h,**h,**h,**h,**h,**h):Input signal

Ex) 1920 x 1080

'0'-'7'-'8'-'0'-'0'-'4'-'3'-'8' : 1920(0768h) x 1080(0438h)

Data(5) : Check INPUT AUDIO

※Same as VCP(Page2 2EH Select Sound Input) reply parameter.

Refer to Item "AUDIO INPUT" on page 33.

Data(6) : Check with or without Audio

'0'-'0' (30h,30h): Audio in

'0'-'1' (30h,31h): No Audio in

'0'-'2' (30h,32h): N/A

Data(7) : Check status (Picture)

'0'-'0' (30h,30h): Normal Picture

'0'-'1' (30h,31h): No Picture

Data(8) : Check status (Audio)

'0'-'0' (30h,30h): Normal Audio

'0'-'1' (30h,31h): No Audio

Data(9)-Data(10) : Year

'*'-'*'-'*'-'*' (**h,**h,**h,**h) :0~65535(0000h~FFFFh)

Ex) 2014

'0'-'7'-'D'-'E' : 2014(07DEh)

Data(11) : month

'0'-'1' (30h,31h): January

'0'-'2' (30h,31h): February

|

'0'-'B' (30h,31h): November

'0'-'C' (30h,31h): December

Data(12) : day

'*'-'*' (**h,**h) :1~31(01h~1Fh)

Date(13) : hour

'*'-'*' (**h,**h) :0~23(00h~17h)

Date(14) :min

'*'-'*' (**h,**h) :0~59(00h~3Bh)

Data(15) : sec

'*'-'*' (**h,**h) :0~59(00h~3Bh)

Data(16)-Data(18) : Reserve(future use : always '0'-0'-0'-0'-0'-0')

ETX (03h): End of Message

Check code

BCC: Block Check Code

Refer to the section 4.3 "Check code" for a BCC calculation.

Delimiter

CR (0Dh): End of packet

23.3 Get Proof of Play Status

This command is used in order to get Proof of Play Status.

- 1) The controller requests the monitor to get status of Proof of Play.

| Header | Message | Check code | Delimiter |
|------------------------------------|---------------------------------|------------|-----------|
| SOH-'0'-Monitor ID-'0'-'A'-'0'-'8' | STX-'C'-'A'-'1'-'5'-'0'-'2'-ETX | BCC | CR |

Header

SOH (01h) : Start of Header
 '0' (30h) : Reserved
 Monitor ID : Specify the Monitor ID from which you want to get status.
 Ex.) If Monitor ID is '1', specify 'A'.
 '0' (30h) : Message sender is the controller.
 'A' (41h) : Message Type is "Command".
 '0'-'8' (30h, 38h) : Message length is 8 bytes.

Message

STX (02h): Start of Message
 'C'-'A'-'1'-'5'
 6': Proof of Play command
 '0'-'2' (30h,32h): Get Proof of Play Status command
 ETX (03h): End of Message

Check code

BCC: Block Check Code
 Refer to the section 4.3 "Check code" for a BCC calculation.

Delimiter

CR (0Dh): End of packet

- 2) The monitor replies the status of Proof of Play to the controller.

| Header | Message | Check code | Delimiter |
|------------------------------------|---|------------|-----------|
| SOH-'0'-Monitor ID-'0'-'B'-'1'-'4' | STX-'C'-'B'-'1'-'5'-'0'-'2'-ST1-ST2-ST3-ST4-ST5-ST6-ETX | BCC | CR |

Header

SOH (01h) : Start of Header
 '0' (30h) : Reserved
 Monitor ID : Specify the Monitor ID from which you want to get status.
 Ex.) If Monitor ID is '1', specify 'A'.
 '0' (30h) : Message sender is the controller.
 'A' (41h) : Message Type is "Command".
 '1'-'4' (31h, 34h) : Message length is 20 bytes.

Message

STX (02h): Start of Message
 'C'-'B'-'1'-'5': Proof of Play reply command
 '0'-'2' (30h,32h): Get Proof of Play status command
 ST1: Error status
 00h (30h, 30h): No Error
 01h (30h, 30h): Memory full (some date has been lost)
 02h (30h, 30h): other error (other error has priority ver 01h error)
 ST2: Total Number-High byte (How many log data items are currently used.)
 ST3: Total Number-Low byte (How many log data items are currently used.)
 '0','0','0','0' - 'F','F','F','F' (30h,30h,30h,30h - 46h,46h,46h,46h): 0-65535

ST4: Maximum Number-High byte (Maximum possible number of log data items)
ST5: Maximum Number-Low byte (Maximum possible number of log data items)
 '0','0','0','0' - 'F','F','F','F' (30h,30h,30h,30h - 46h,46h,46h,46h): 0 - 65535
ST6: Current Proof of Play status.
 Stop: 00h (30h, 30h)
 Start: 01h (30h, 31h)
ETX (03h): End of Message

Check code

BCC: Block Check Code
Refer to the section 4.3 "Check code" for a BCC calculation.

Delimiter

CR (0Dh): End of packet

23.4 Get Proof of Play Number to Number

This command is used in order to get Proof of Play number to number log.

- 1) The controller requests the monitor to get Number to Number log of Proof of Play.

| Header | Message | Check code | Delimiter |
|------------------------------------|---|------------|-----------|
| SOH-'0'-Monitor ID-'0'-'A'-'1'-'0' | STX-'C'-'A'-'1'-'5'-'0'-'3'-BNS(H)-BNS(L)-BNE(H)-BNE(L)-ETX | BCC | CR |

Header

SOH (01h) : Start of Header
 '0' (30h) : Reserved
 Monitor ID : Specify the Monitor ID from which you want to get status.
 Ex.) If Monitor ID is '1', specify 'A'.
 '0' (30h) : Message sender is the controller.
 'A' (41h) : Message Type is "Command".
 '1'-'0' (31h, 30h) : Message length is 16 bytes.

Message

STX (02h): Start of Message
 'C'-'A'-'1'-'5': Proof of Play command
 '0'-'3' (30h,33h): Get Proof of Play Number to Number log command
 BNS(H): Block Number of Start (High byte)
 BNS(L): Block Number of Start (Low byte)
 BNE(H): Block Number of Stop (High byte)
 BNE(L): Block Number of Stop (Low byte)
 ETX (03h): End of Message

Check code

BCC: Block Check Code
 Refer to the section 4.3 "Check code" for a BCC calculation.

Delimiter

CR (0Dh): End of packet

- 2) The monitor replies the number to number log of Proof of Play to the controller.

| Header | Message | Check code | Delimiter |
|------------------------------------|---|------------|-----------|
| SOH-'0'-Monitor ID-'0'-'B'-'3'-'4' | STX-'C'-'B'-'1'-'5'-'0'-'3'- LNR(H)-LNR(L)-Data(0)-Data(1)-Data(2) ---Data(18) -ETX | BCC | CR |

* A reply returns data in order from specified Number to specified Number.

Ex) Number to Number: 1 to 6

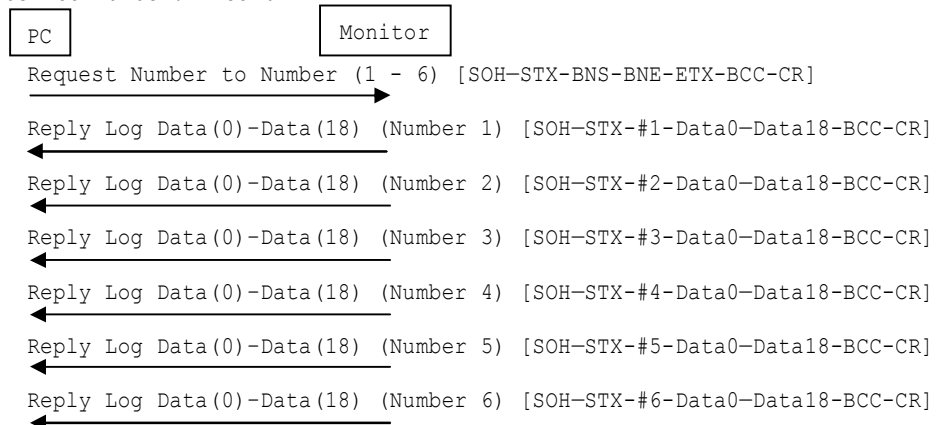

Header

SOH (01h) : Start of Header

'0' (30h) : Reserved
Monitor ID : Specify the Monitor ID from which you want to get status.
 Ex.) If Monitor ID is '1', specify 'A'.
'0' (30h) : Message sender is the controller.
'A' (41h) : Message Type is "Command".
'3'-'4' (33h, 36h) : Message length is 38 bytes.

Message

STX (02h): Start of Message
'C'-'B'-'1'-'5': Proof of Play reply command
'0'-'3' (30h,33h): Get Proof of Play Number to Number log command
LNR (H): log number being returned (High byte)
LNR (L): log number being returned (Low byte)
Data(0)-Data(12): Log Data of Proof of Play of STOP (26byte) : Same as "Get Proof of Play Current"
* Refer to "Get Proof of Play Current"
ETX (03h): End of Message

Check code

BCC: Block Check Code
Refer to the section 4.3 "Check code" for a BCC calculation.

Delimiter

CR (0Dh): End of packet

All data are subject to change without notice.

(February. 9, 2015)

Copyright 2004-2015 NEC Display Solutions, Ltd. All Right Reserved

This document provides the technical information for users. NEC Display Solutions, Ltd. reserves the right to change or modify the information contained herein without notice. NEC Display Solutions, Ltd. makes no warranty for the use of its products and bears no responsibility for any errors or omissions which may appear in this document.