

ME301X/ME331X/ME361X/ME401X Installation Guide

Ceiling Mounted and Desktop

Rev 1.0

Contents

Product Description, Lens Specs, Notes and Formulas_____	Pg 1
Diagrams & Distance Charts_____	Pg 2
Cabinet Dimensions_____	Pg 3-4
Ceiling Mount Dimensions_____	Pg 5
Input Panel and Control Codes_____	Pg 6



Product Description

Type:	3 panel LCD Projector 0.59" DMD	Dimensions:	13.4" (W) x 4.2" (H) x 10.3" (D)
Resolution:	1280 x 800	Weight:	6.4 lbs
Fan Noise:	ME301X: 35dB / 29dB @ 1 meter ME331X: 36dB / 29dB @ 1 meter ME361X: 36dB / 29dB @ 1 meter ME401X: 37dB / 29dB @ 1 meter	Brightness:	ME301X: 3000 Lumens ME331X: 3300 Lumens ME361X: 3600 Lumens ME401X: 4000 Lumens
Power Consumption:	ME301X: 286W (max) ME331X: 309W (max) ME361X: 309W (max) ME401X: 316W (max)	BTU's:	ME301X: 976 BTU/hour ME331X: 1054 BTU/hour ME361X: 1054 BTU/hour ME401X: 1078 BTU/hour

Lens Specifications

Throw Ratio:	1.3 – 2.2:1 (for 100" diagonal)	Focal Length:	17.5mm – 29.0mm
Offset Angle:	6.6° - 10.9° (for 100" diagonal)	F/#:	1.7 - 2.1
Screen Sizes:	30" - 300" diagonal (4:3)		Manual Focus/Manual Zoom

Notes

- For screen sizes not indicated on the projection tables, use the formulas below. If the figures on the tables do not match the results of formulas, use the figures in the table.
- All calculations are based on a 4:3 aspect ratio.
- Distances are in inches, for millimeters multiply by 25.4.
- Distances may vary ±5%.

Formulas

The Projection Formulas use the image width for calculation. For proper projection placement, determine the image width for the desired screen size. Use the Screen Formulas below to calculate all screen dimensions. Plug in the width for "W" in the Projection Formulas.

Refer to the diagrams and charts for popular screen sizes on page 2:

Definitions:

- W = Image Width
- H = Image Height (size)
- B = Vertical distance between lens center and screen center
- C = Throw distance
- D = Vertical distance between lens center and screen top
(screen bottom for desktop application)

ME301X/ME331X/ME361X/ME401X Installation Guide

Ceiling Mounted and Desktop

Rev 1.0

Diagrams and Distance Charts

The following shows the proper relative positions of the projector and screen. Refer to the table to determine the position of installation.

Distances are in inches. For millimeters multiply by 25.4.

Ceiling Mounted

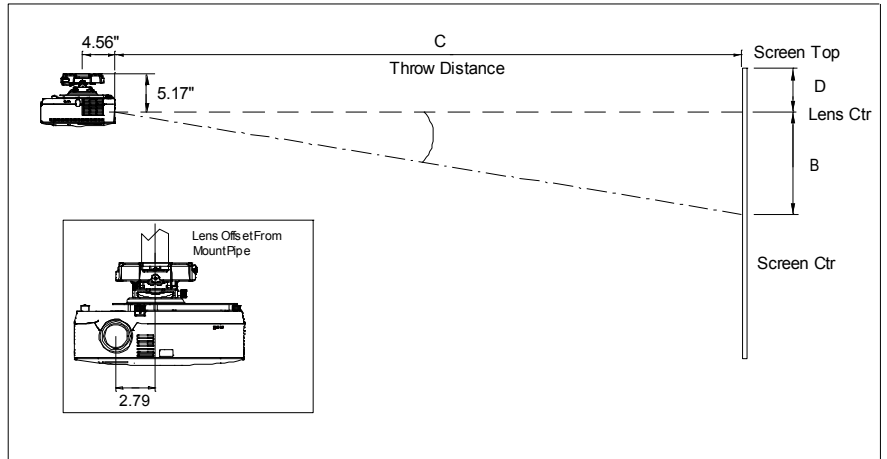

Desktop

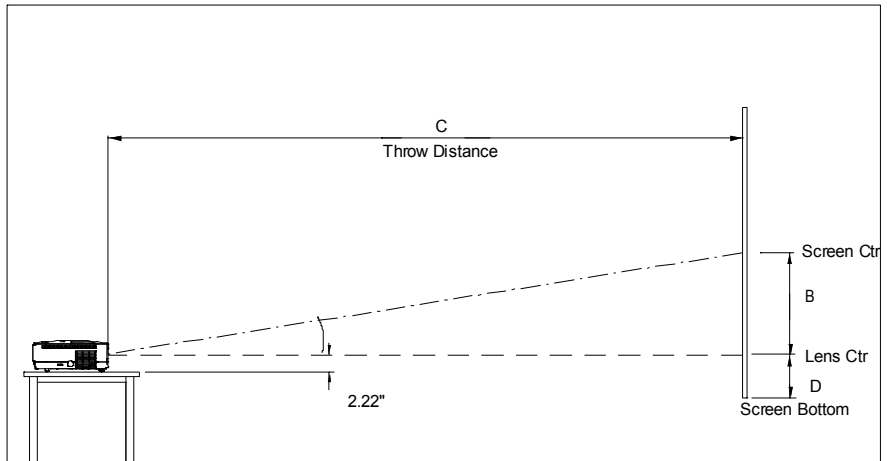

Distance Chart for popular 4:3 screens

4:3 Screen Formulas:

$$W = \text{Image Width} = H \times 4/3$$

$$H = \text{Image Height} = W \times 3/4$$

$$\text{Screen Diagonal} = W \times 5/4$$

Projection Formulas:

$$B = 0.2578W$$

$$C (\text{wide}) = 1.366W - 1.77$$

$$C (\text{tele}) = 2.268W - 1.77$$

$$D = -0.117W$$

$$\alpha (\text{wide}) = \tan^{-1} (B/C(\text{wide}))$$

$$\alpha (\text{tele}) = \tan^{-1} (B/C(\text{tele}))$$

Note: For screen sizes not indicated on the projection tables, use the formulas on page 1.

Screen Size (4:3)			B	C		D	α	
Diagonal	Width(W)	Height (H)	inches	wide - tele		inches	wide - tele	
inches	inches	inches		inches	inches		degrees	
30	24	18	6	31	- 53	-3	11.3	- 6.7
60	48	36	12	64	- 107	-6	11.0	- 6.6
67	54	40.2	14	71	- 120	-6	10.9	- 6.6
72	58	43.2	15	77	- 129	-7	10.9	- 6.6
84	67	50.4	17	90	- 151	-8	10.9	- 6.6
90	72	54	19	97	- 162	-8	10.9	- 6.6
100	80	60	21	108	- 180	-9	10.9	- 6.5
120	96	72	25	129	- 216	-11	10.8	- 6.5
150	120	90	31	162	- 270	-14	10.8	- 6.5
180	144	108	37	195	- 325	-17	10.8	- 6.5
210	168	126	43	228	- 379	-20	10.8	- 6.5
240	192	144	49	261	- 434	-22	10.8	- 6.5
270	216	162	56	293	- 488	-25	10.8	- 6.5
300	240	180	62	326	- 543	-28	10.7	- 6.5
158	126	79	33	170	- 284	-7	10.8	- 6.5
226	181	113	47	244	- 407	-10	10.8	- 6.5
255	216	135	56	292	- 486	-12	10.8	- 6.5

ME301X/ME331X/ME361X/ME401X Installation Guide

Ceiling Mounted and Desktop

Rev 1.0

Cabinet Dimensions

The following drawings show the cabinet dimensions.
Dimensions are in inches. For millimeters multiply by 25.4.

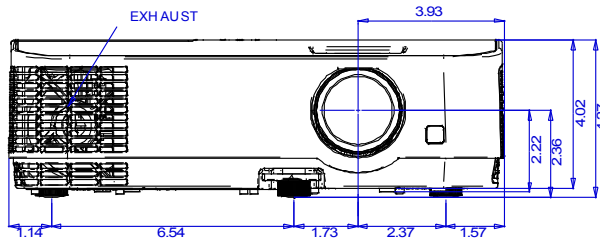
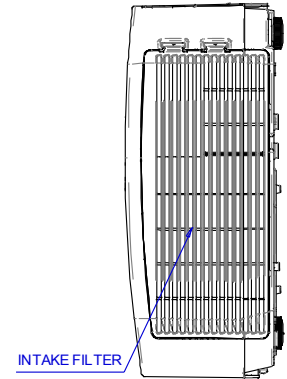
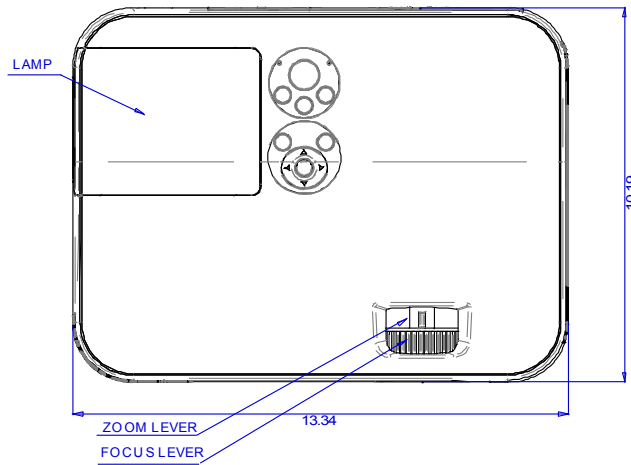
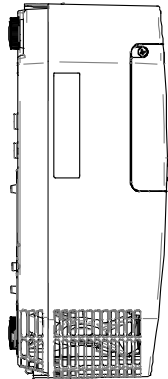
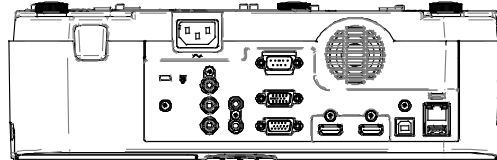

ME301X/ME331X/ME361X/ME401X Installation Guide

Ceiling Mounted and Desktop

Rev 1.0

Cabinet Dimensions (continued)

The following drawings show the cabinet dimensions.
Dimensions are in inches. For millimeters multiply by 25.4.

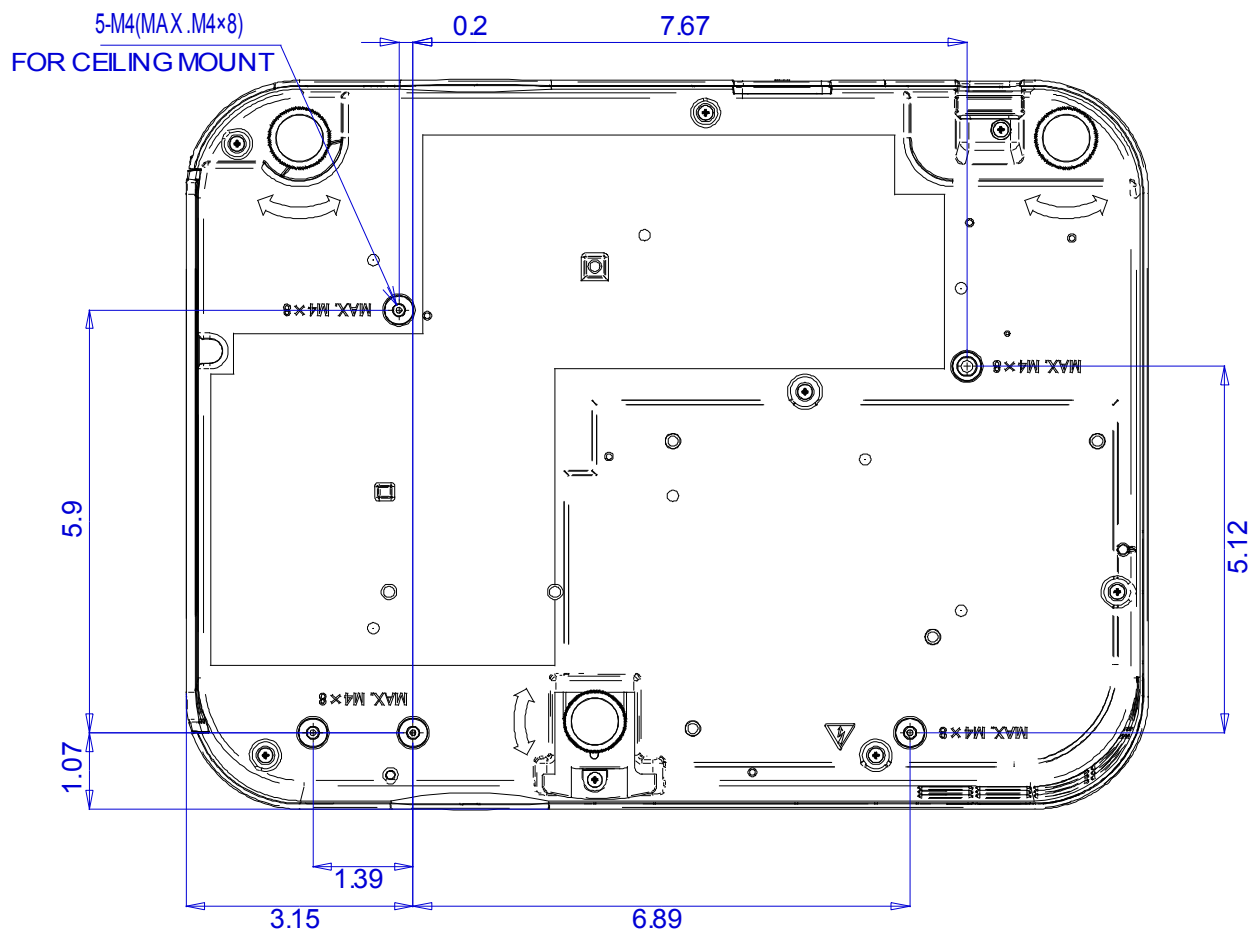

ME301X/ME331X/ME361X/ME401X Installation Guide

Ceiling Mounted and Desktop

Rev 1.0

Optional Ceiling Mount Dimensions (Model #: MP300CM)

The following drawings show the ceiling mount dimensions.
Dimensions are in inches. For millimeters multiply by 25.4.

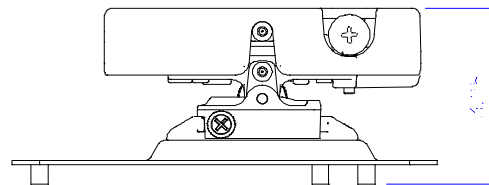
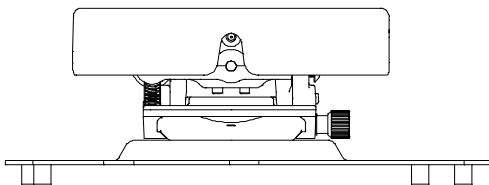
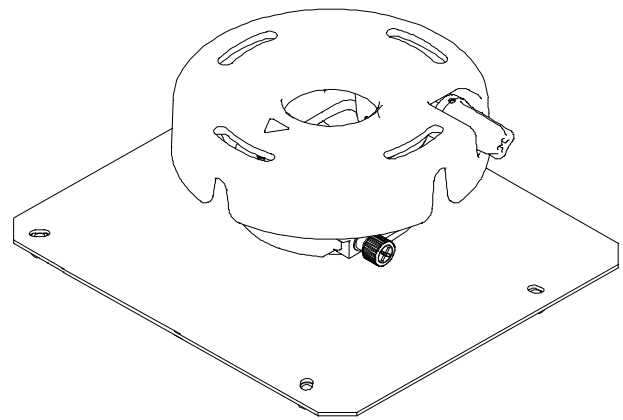
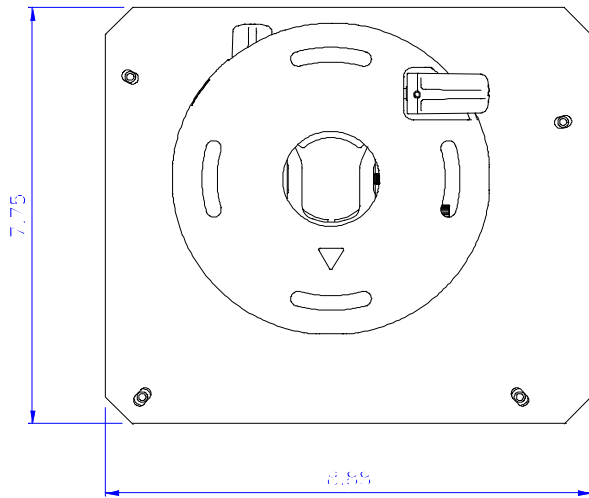

ME301X/ME331X/ME361X/ME401X Installation Guide

Ceiling Mounted and Desktop

Rev 1.0

Input / Output Panel



PC Control Codes

Function	Code Data
POWER ON	02H 00H 00H 00H 00H 02H
POWER OFF	02H 01H 00H 00H 00H 03H
INPUT SELECT COMPUTER1	02H 03H 00H 00H 02H 01H 01H 09H
INPUT SELECT HDMI 1	02H 03H 00H 00H 02H 01H 1AH 22H
INPUT SELECT HDMI 2	02H 03H 00H 00H 02H 01H 1BH 23H
INPUT SELECT VIDEO	02H 03H 00H 00H 02H 01H 06H 0EH
INPUT SELECT VIEWER (USB-A)	02H 03H 00H 00H 02H 01H 1FH 27H
INPUT SELECT NETWORK	02H 03H 00H 00H 02H 01H 20H 28H
INPUT SELECT USB DISPLAY (USB-B)	02H 03H 00H 00H 02H 01H 22H 2AH
PICTURE MUTE ON	02H 10H 00H 00H 00H 12H
PICTURE MUTE OFF	02H 11H 00H 00H 00H 13H
SOUND MUTE ON	02H 12H 00H 00H 00H 14H
SOUND MUTE OFF	02H 13H 00H 00H 00H 15H
PROJECTOR INFORMATION REQUEST	00H BFH 00H 00H 01H 02H C2H
ERROR STATUS REQUEST	00H 88H 00H 00H 00H 88H
INFORMATION REQUEST	03H 8AH 00H 00H 00H 8DH

Note: Contact your NEC rep for codes not listed.

Cable Connection

Communication Protocol:

Baud Rate: 38400 bps
 Data Length: 8 bits
 Parity: No Parity
 Stop Bit: One Bit
 X on/off: None
 Communications: Full duplex

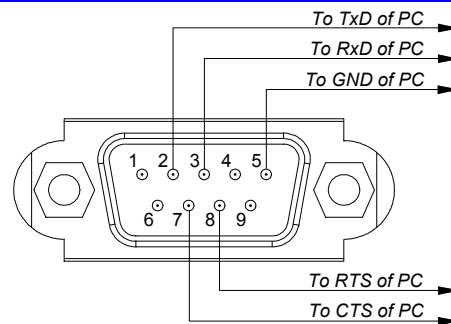

PC Control Connector (D-Sub 9P)

NOTE 1 : Pins 1, 4, 6, and 9 are used inside the projector.

NOTE 2 : For long cable runs it is recommended to set communication speed within the projector to 9600 bps.

NOTE 3 : Jumper "Request to Send" and "Clear to Send" together on both ends of the cable to simplify cable connection.