

## 42VR5/42XR3 Installation Guide

### 42" Plasma Displays

v1.3

#### Contents

Product Description and Notes	Page 1
Ventilation Requirements	Page 2
Display Dimensions	
Front, Top & Bottom	Page 3
Rear	Page 4
Left & Right Side	Page 5
Display Dimensions w/Optional Speakers and Stand	Page 6
Dimensions w/Optional Flat Wall Mount	Page 7
Dimensions w/Optional Tilt Wall Mount	Page 8
Dimensions w/Optional Ceiling Mount	Page 9
Connections	Page 10
Control Codes	Page 11

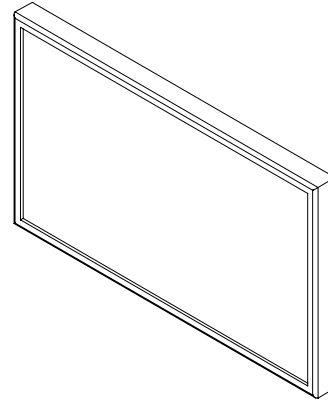

#### Product Description

Type:	Plasma Display	Screen Surface:	Anti-Reflective
Resolution:	42VR5: 853x480 42XR3: 1024x768	Dimensions:	40"(W) x 24"(H) x 3.5"(D)
Aspect Ratio:	16:9	Weight:	42VR5: 62.8 lbs 42XR3: 65.0 lbs
Color Correction:	NEC CCF (Capsulated Color Filter, in panel) and AccuCrimson (in front filter)		

#### Notes

- This document is intended to be used as a reference guide to supply useful information for a design or installation. It is not intended to be a step-by step procedure for installation.
- Any ceilings or walls must be strong enough to support the display and the installation must be in accordance with any local building codes. All mounts should make secure contact to wood studs.
- 4:3 sources can be displayed on the 16:9 screen in either normal aspect ratio with bars on the left or right, or stretched horizontally to fill the screen using the menus (see "Aspect Modes" in menus and user manual).
- Distances are in inches, for millimeters multiply by 25.4.
- Distances may vary  $\pm 5\%$ .

#### Maximum Tilt Angles

Below are the maximum angles that the display can be tilted in both landscape and portrait mode

Landscape 30°

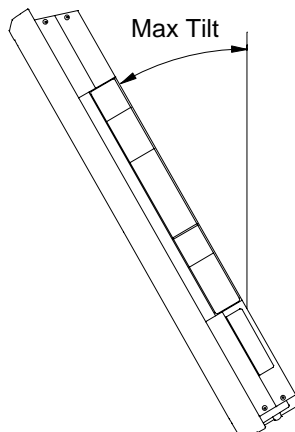

## Ventilation Requirements (all models)

Dimensions below are minimum required for proper ventilation.

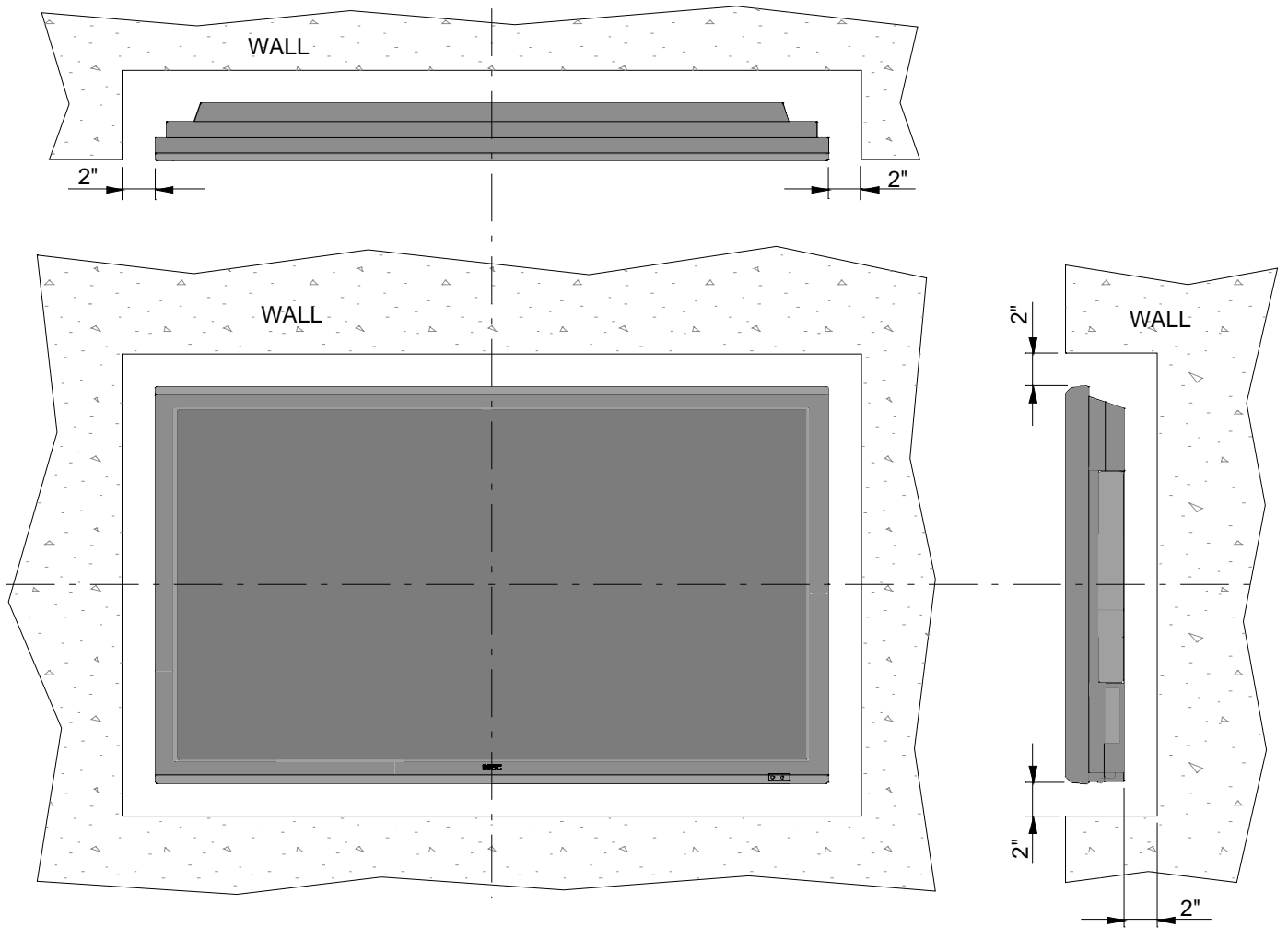

**NOTE:** The ventilation space should not be covered or closed off at the front of the opening. If for some reason the opening needs to be covered, other means of ventilation will need to be incorporated into the design. Contact NEC for design review and recommendations.

# Display dimensions

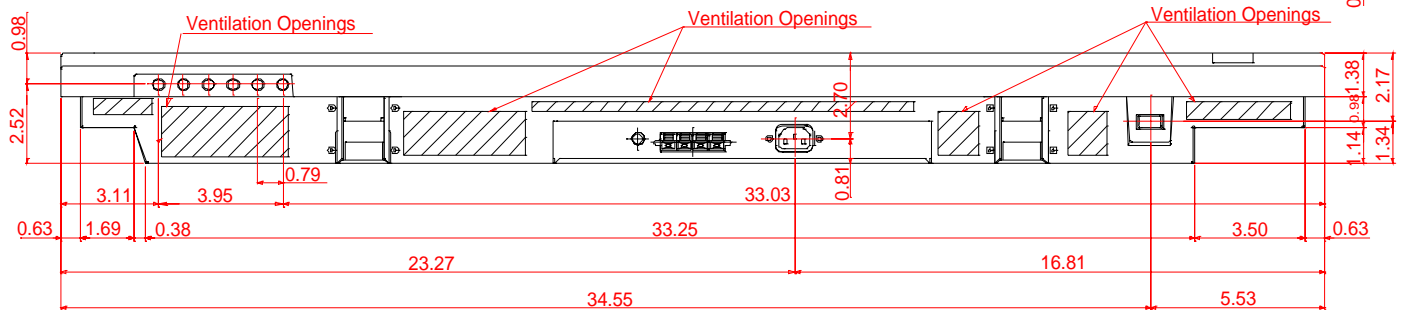
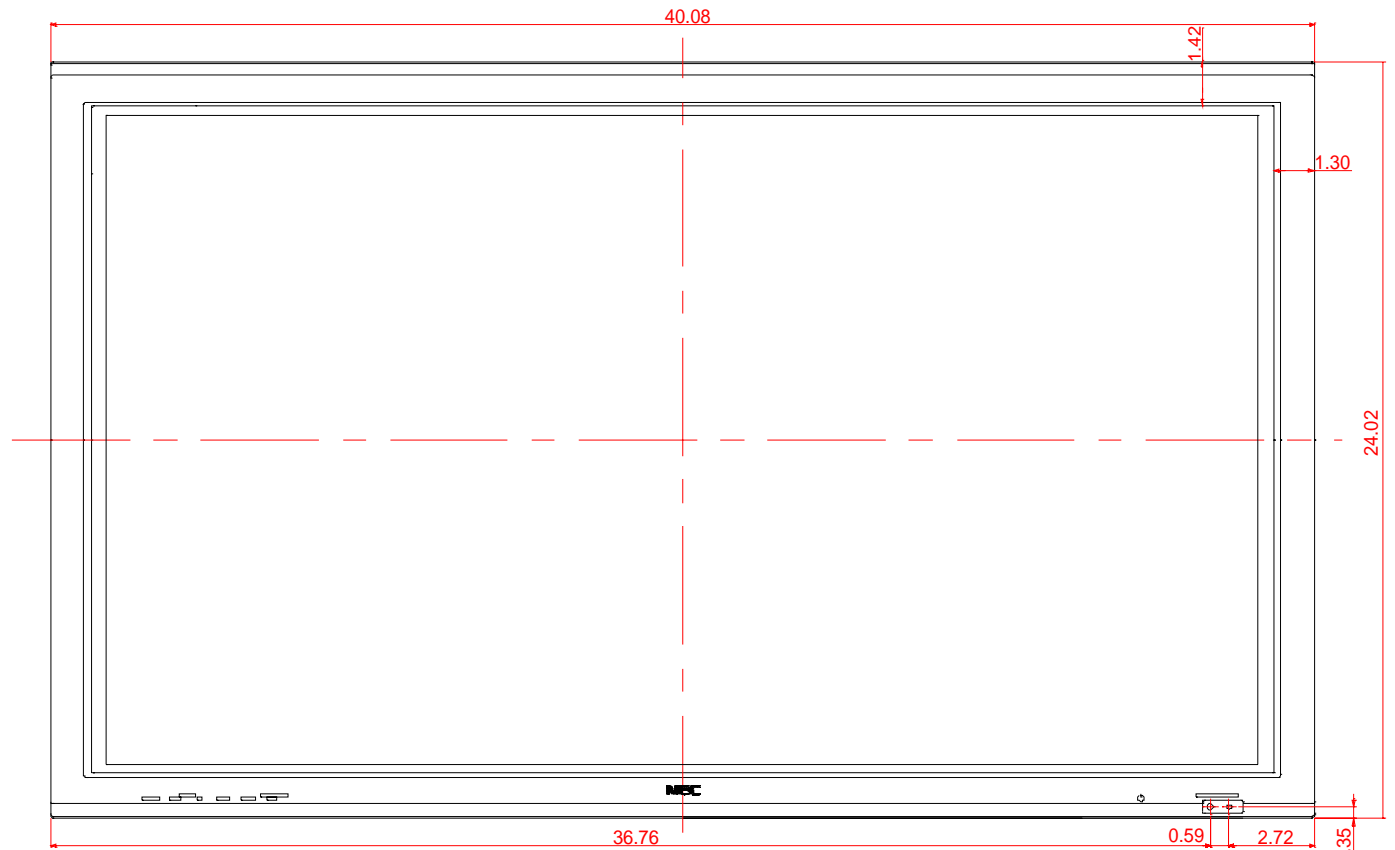
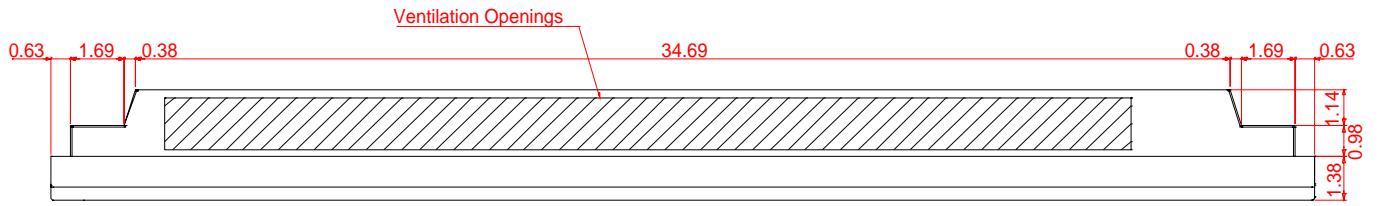

# Display dimensions (cont.)

## 42VR5 Rear View

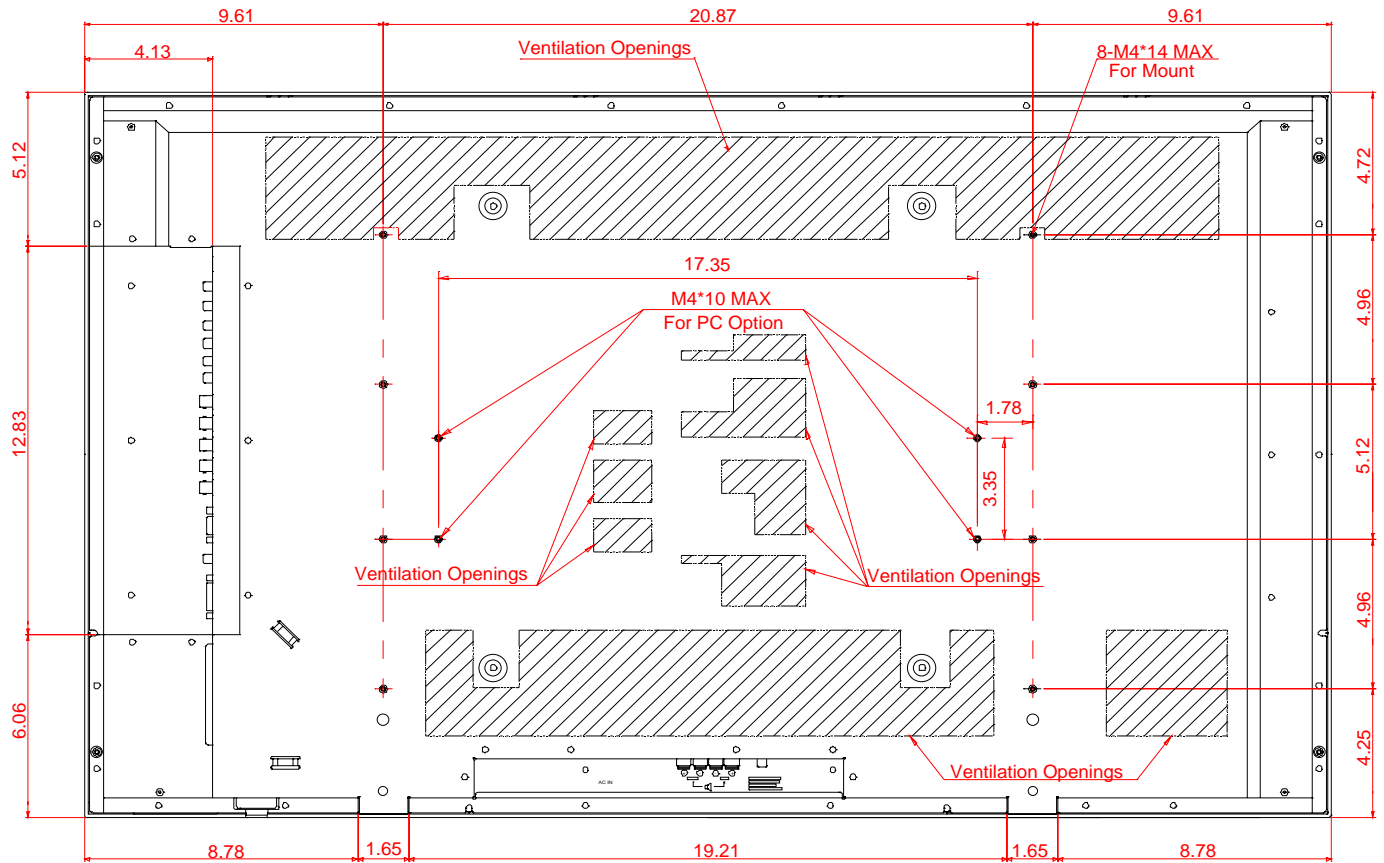

## 42XR3 Rear View (rear ventilation different)

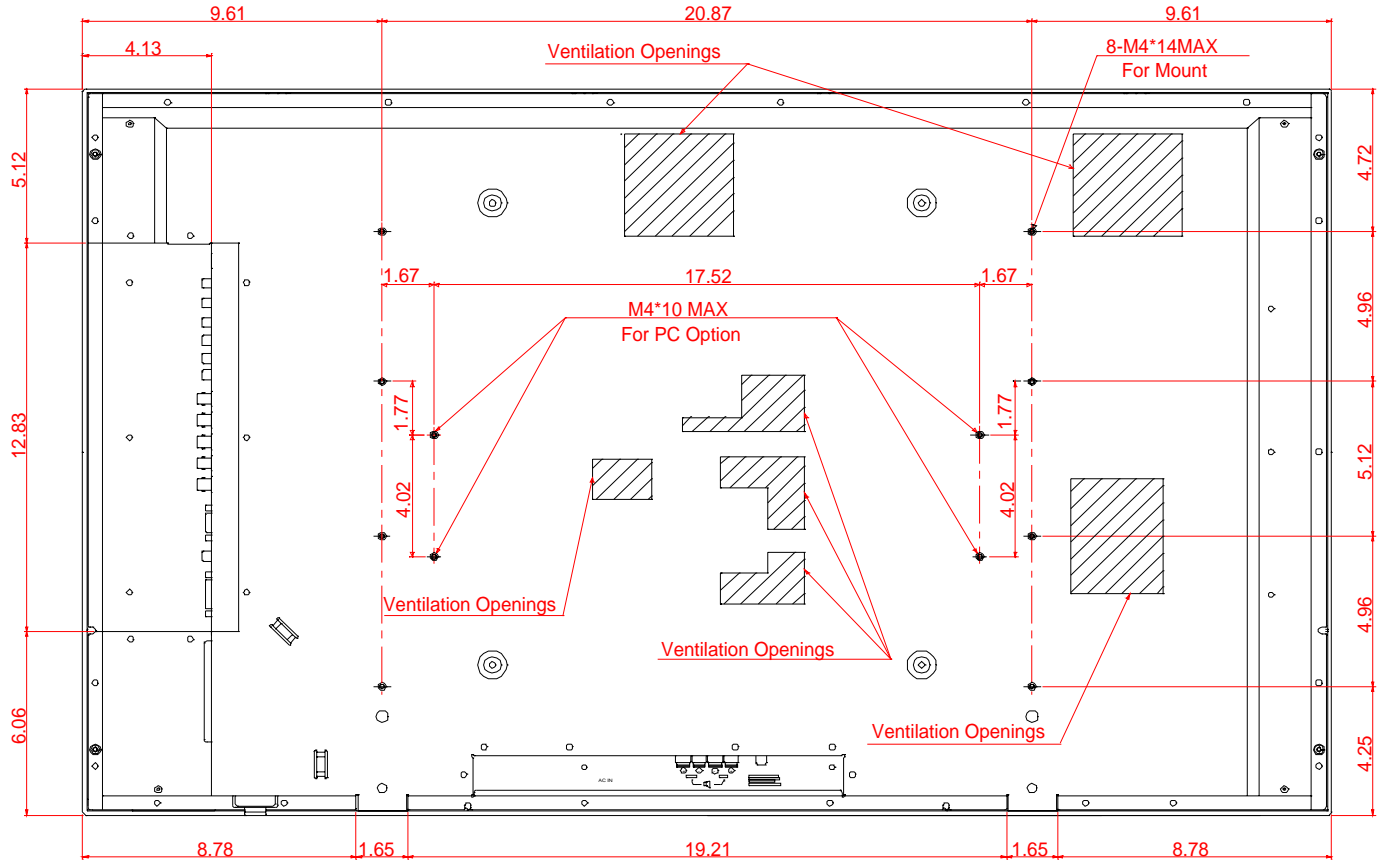

# Display dimensions (cont.)

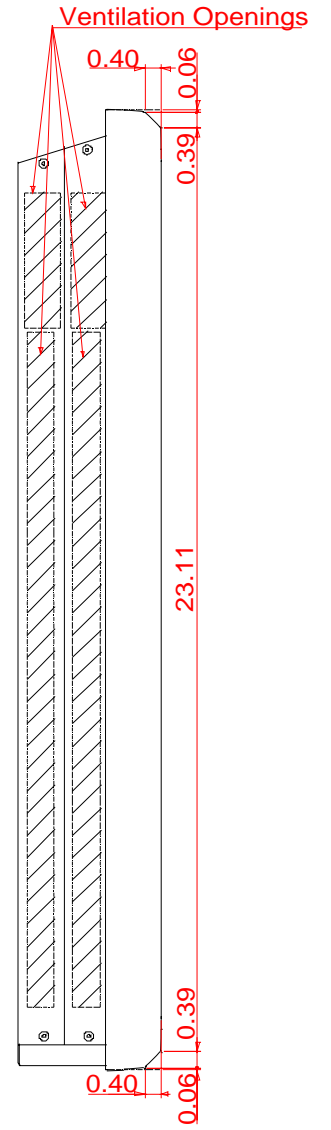
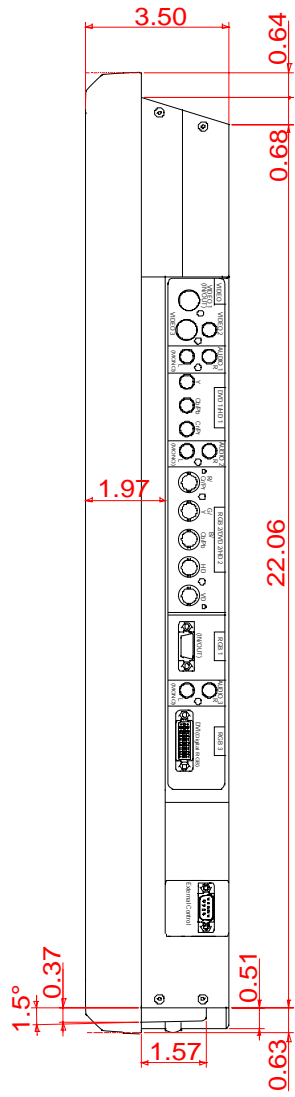



# Dimensions with optional Flat Wall Mount Kit (FWMK)

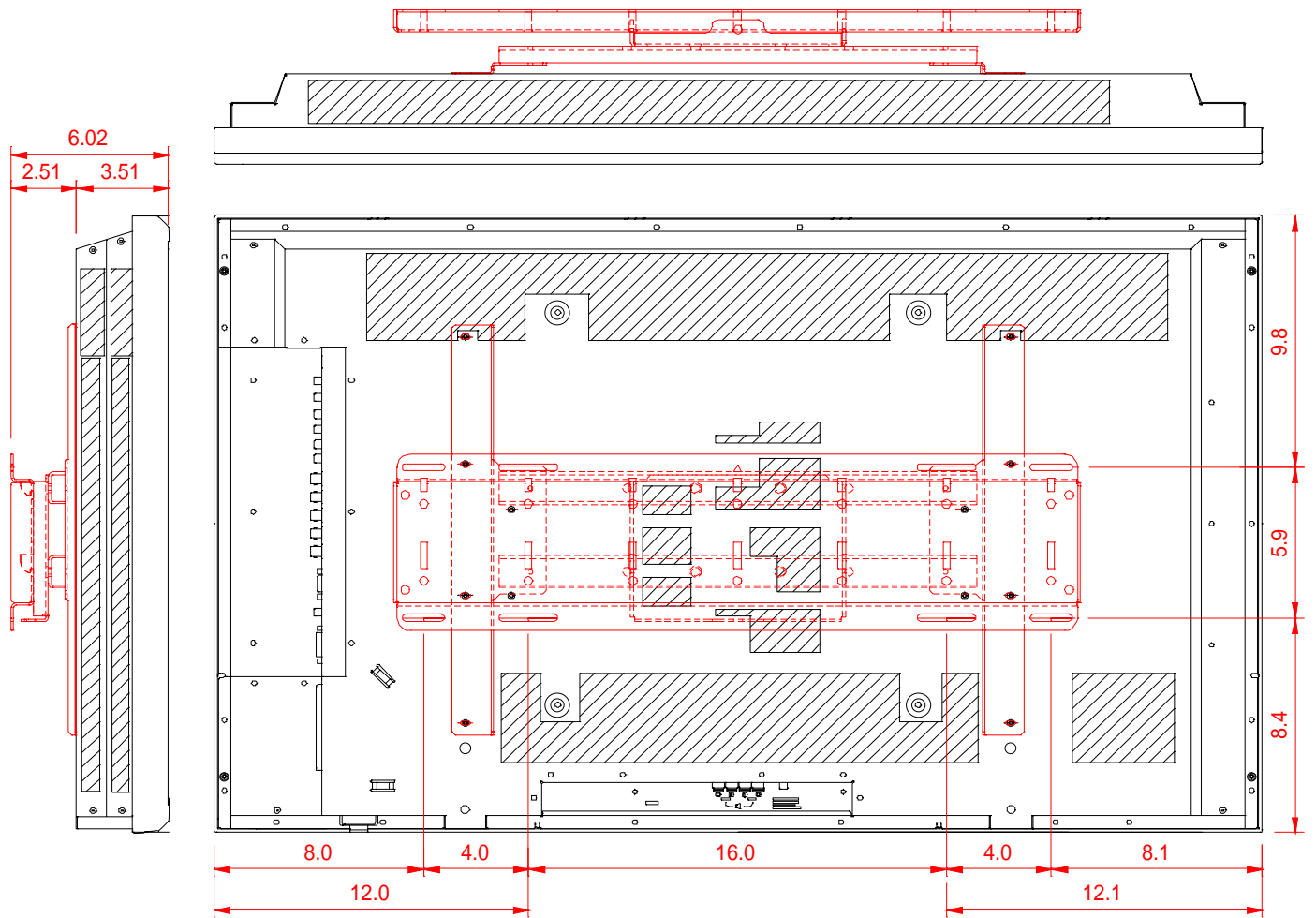

# Dimensions with optional Tilt Wall Mount Kit (TWMK)

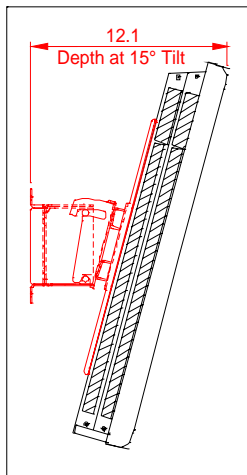
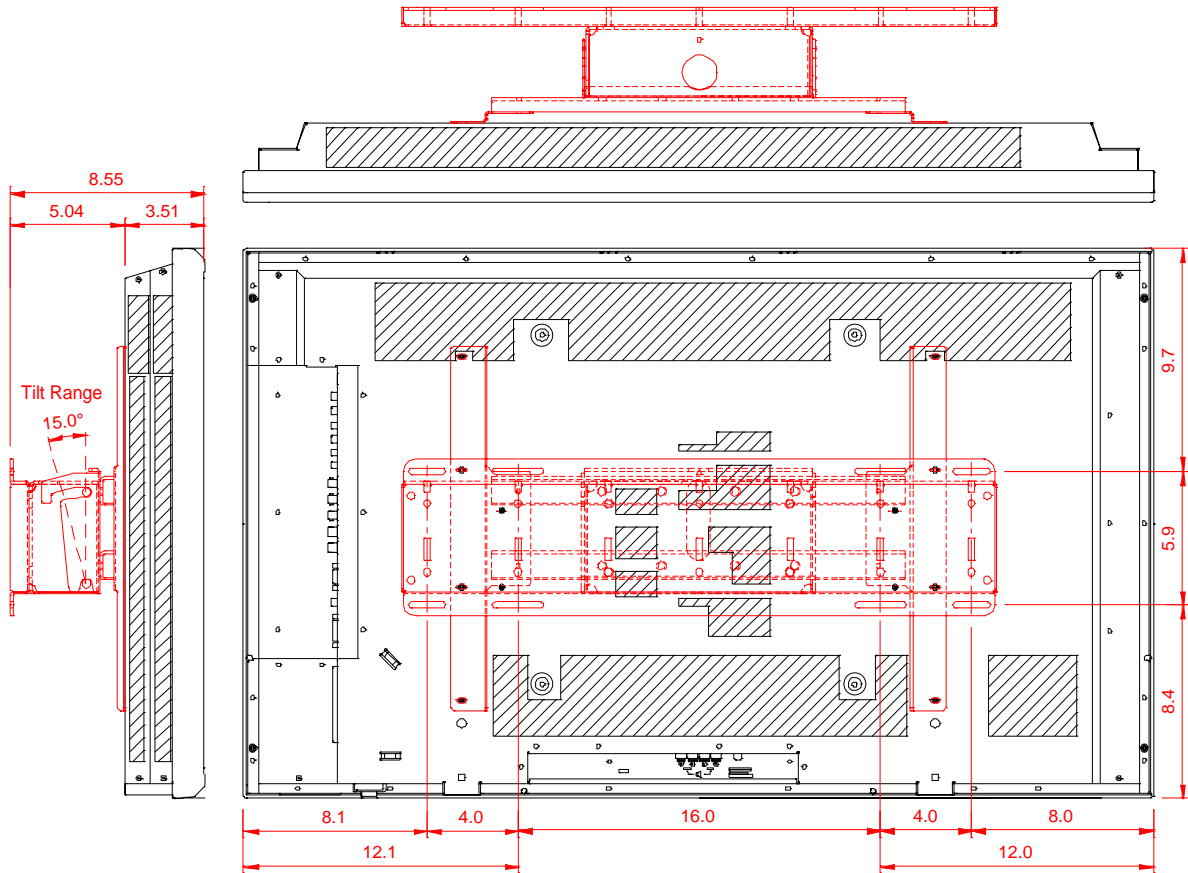



# Dimensions with optional Ceiling Mount Kit (CMK)

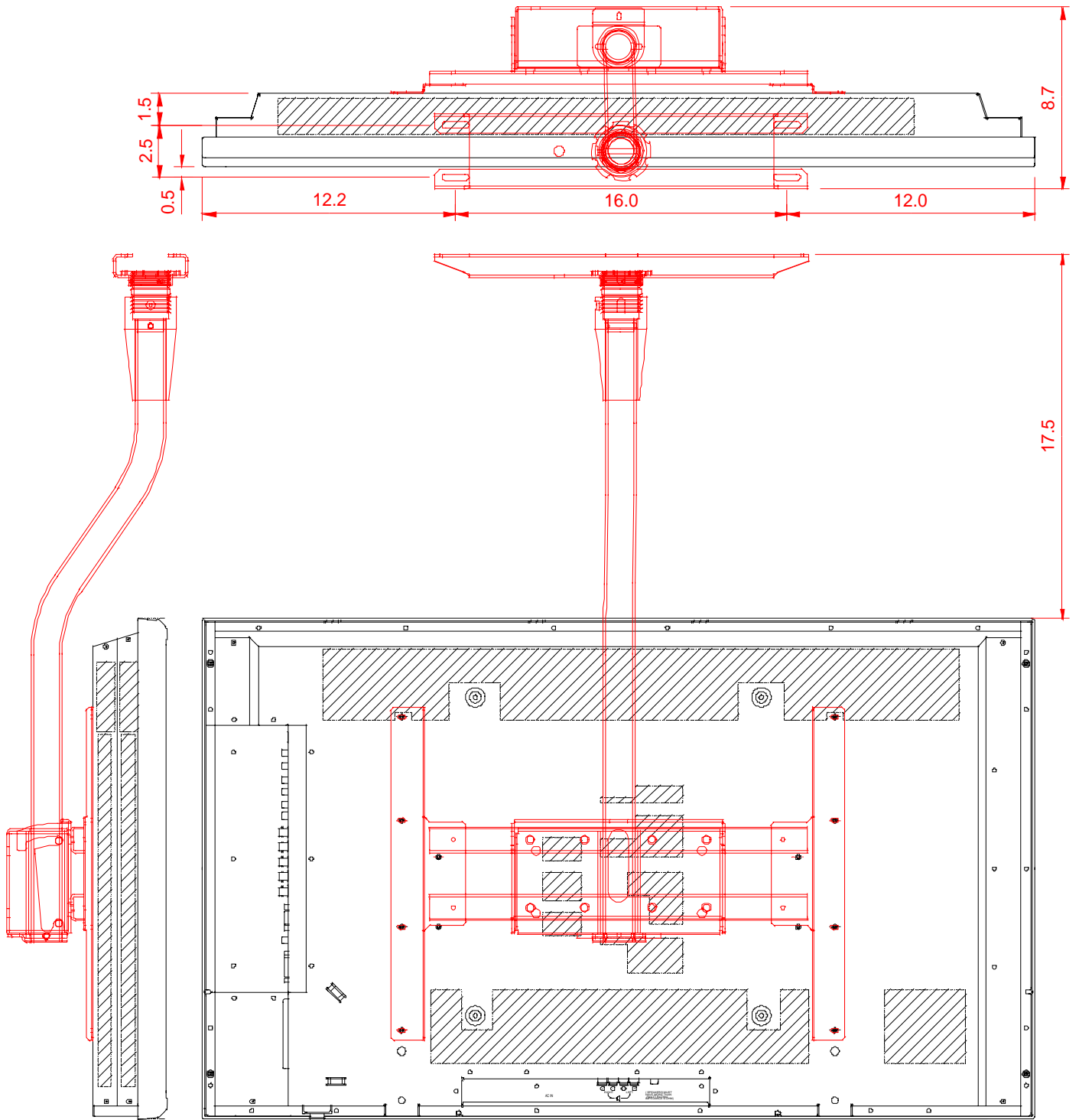

# Connections

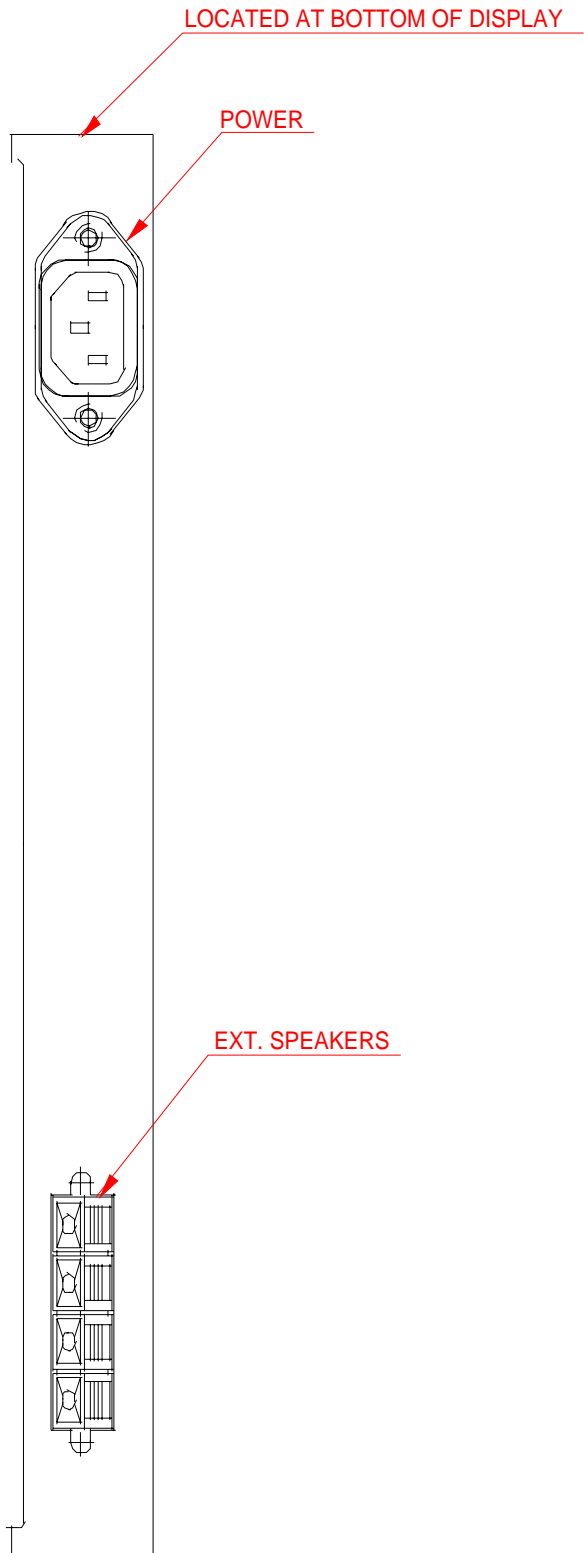
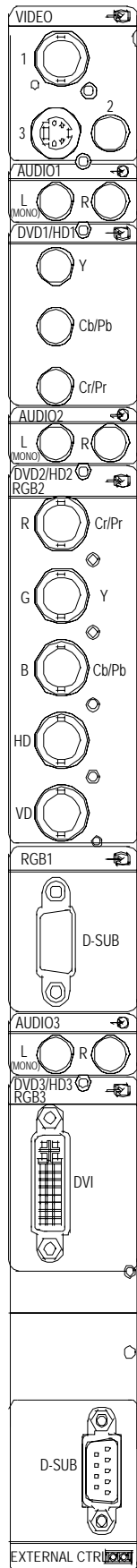

## Control Codes

Function		Code Data							
POWER	ON	9FH	80H	60H	4EH	00H	CDH		
	OFF	9FH	80H	60H	4FH	00H	CEH		
INPUT SWITCH	VIDEO1 (BNC)	DFH	80H	60H	47H	01H	01H	08H	
	VIDEO2 (RCA)	DFH	80H	60H	47H	01H	02H	09H	
	VIDEO3 (S-Video)	DFH	80H	60H	47H	01H	03H	0AH	
	DVD1/HD1 (RCA/Component)	DFH	80H	60H	47H	01H	05H	0CH	
	DVD2/HD2 (5BNC/Component)	DFH	80H	60H	47H	01H	06H	0DH	
	RGB1 (15pin HD)	DFH	80H	60H	47H	01H	07H	0EH	
	RGB2 (5BNC/RGB)	DFH	80H	60H	47H	01H	08H	0FH	
	RGB3 (DVI)	DFH	80H	60H	47H	01H	0CH	13H	
AUDIO MUTE	ON	9FH	80H	60H	3EH	00H	BDH		
	OFF	9FH	80H	60H	3FH	00H	BEH		
PICTURE MODE	NORMAL	DFH	80H	60H	0AH	01H	01H	CBH	
	THEAT.1	DFH	80H	60H	0AH	01H	02H	CCH	
	THEAT.2	DFH	80H	60H	0AH	01H	03H	CDH	
	DEFAULT	DFH	80H	60H	0AH	01H	04H	CEH	
SCREEN MODE:	STADIUM	DFH	80H	60H	51H	01H	02H	13H	
	ZOOM	DFH	80H	60H	51H	01H	03H	14H	
	NORMAL	DFH	80H	60H	51H	01H	04H	15H	
	FULL	DFH	80H	60H	51H	01H	05H	16H	
AUTO PICTURE	ON	DFH	80H	60H	7FH	03H	03H	09H	00H 4DH
	OFF	DFH	80H	60H	7FH	03H	03H	09H	01H 4EH
CINEMA MODE	ON	DFH	80H	60H	C1H	01H	01H	82H	
	OFF	DFH	80H	60H	C1H	01H	02H	83H	

**NOTE:** Contact your NEC rep for codes not listed.

**NOTE:** Use a cross/reverse/null modem cable.

## Cable Connection

### Communication Protocol:

Interface:	RS-232C	Parity:	Odd
Communication:	Asynchronous	Stop Bit:	1 bit
Baud Rate:	9600 bps	Communication Code:	Hex
Data Length:	8 bits		

### PC Control Connector (D-Sub 9P)

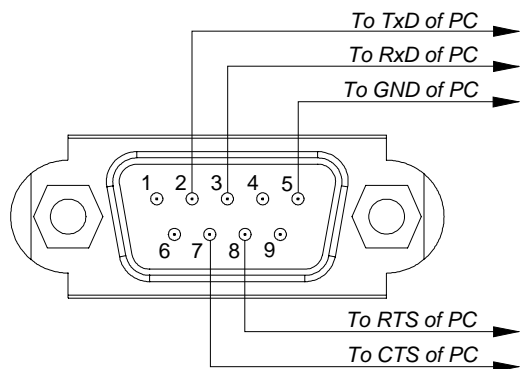

**NOTE:** Jumper "Request to send" and "Clear to Send" together on both ends of the cable to simplify cable connection.